

Table of Contents

Page

3	Introduction
4	Safety Information
4	Unpacking
5	Terminology
6	Features
7	Front Panel Controls
8	Front Panel Display
9	Rear Panel Connections
11	Remote Control
13	Basic Information
13	About This Manual
13	Regional Coding
System Connection	
14	Installation and Connections
14	Audio Connections
14	Video Connections
15	Optional Audio Connections
15	Speaker Placement
16	Connecting AC Power
16	First Turn On
16	Basic Playback
16	Disc Playback Features
16	Skipping tracks or titles/chapters
16	Fast Motion Playback/Fast Search
16	Freeze Frame and Frame Advance (with DVD only)
17	Slow Motion Playback (with DVD only)
17	About DivX Movie Files
17	Surround Mode
System Setup	
18	System Defaults
18	Setup Menu
18	System Settings
18	Display Language
18	Preferred Subtitle Language
18	Panel Time-Out
18	Status Bar Time-Out
18	Parental Control
19	Disc Recognition
19	PBC Support
19	Screen Saver
19	Show Angle Icon
19	Audio Settings
19	Preferred Audio Language
19	Dynamic Range
19	Tone Control
19	Bass Level
19	Treble Level
19	DVD Sound Mode
19	Audio Adjustment
19	Output Level Adjustment
20	Video Settings
20	Aspect Ratio
20	TV Standard
20	Scan Type
20	Video Output
20	Scart Output
20	Video Mode
20	Video Resolution
20	Video Adjustment
Test Screen	
21	Test Screen
21	TV Picture Adjustment with Test Screen
Player Menu	
22	Using the Status Bar Menu
22	Player Menu
22	Information Displays
22	Programmed Play

Radio Menu

23	Rearranging the station list
23	Selecting presets
23	Removing presets
23	Auto Preset function
24	RDS Station ID
24	Surround Mode for Tuner

TV Menu, AUX Menu, Digital In Menu

24	TV Menu
24	AUX Menu
24	Digital Menu
25	Surround Mode Chart

USB Menu

25	USB Menu
----	----------

Remote Control

26	Learning Codes from a Remote
26	Erasing Learned Codes
26	Macro Programming

DVD Languages Codes

27	Languages Codes
----	-----------------

Troubleshooting

28	Troubleshooting
----	-----------------

Glossary

30	Glossary
----	----------

Specifications

31	Specifications
----	----------------

Declaration of Conformity



We, Harman Consumer Group, Inc.
2, route de Tours
72500 Château-du-Loir,
FRANCE

declare in own responsibility, that the product described in this owner's manual is in compliance with technical standards:

EN 55013:2001 + A1:2003

EN 55020:2002 + A1:2003

EN 61000-3-2:2000

EN 61000-3-3:1995 + A1:2001

EN 60065:2002

Jurjen Amsterdam
Harman Consumer Group, Inc.
01/07

Typographical Conventions

In order to help you use this manual with the remote control, front-panel controls and rear-panel connections, certain conventions have been used.

EXAMPLE – (bold type) indicates a specific remote control or front-panel button, or rear-panel connection jack

EXAMPLE – (OCR type) indicates a message that is visible on the front-panel information display

1 – (number in a square) indicates a specific front-panel control

1 – (number in a circle) indicates a rear-panel connection

1 – (number in an oval) indicates a button or indicator on the remote

A – (letter in a square) indicates an indicator on the front panel display

The appearance of the text or cursor for your receiver's on-screen menus may vary slightly from the illustrations in this manual. Whether the text appears in all uppercase or upper- and lowercase characters, performance and operation remain the same.

Introduction

Thank you for choosing Harman Kardon!

With the purchase of a Harman Kardon HS 200 you are about to begin many years of listening enjoyment.

Designed to provide all the excitement and detail of movie soundtracks and every nuance of musical selections using only one pair of stereo loudspeakers and a subwoofer, the HS 200 is truly a multichannel system for the new millennium.

The HS 200 has been engineered so that it is easy to take advantage of all the power of its digital technology. To obtain the maximum enjoyment from your new system, we urge you to read this manual. A few minutes spent learning the functions of the various controls will enable you to take advantage of all the power the HS is able to deliver.

If you have any questions about this product, its installation or its operation, please contact your retailer or custom installer. They are your best local sources of information.

Description and Features

The HS 200 is among the most versatile home cinema systems available, incorporating an Audio Video Controller, a DVD player and a complete 2.1 loudspeaker system in one complete system solution. The Dolby® Virtual Speaker surround modes for Matrix surround-encoded or Stereo recordings is available for use with sources such as CD, VCR, TV broadcasts and the system's own FM tuner.

To enable you to get the maximum quality from DVDs, the HS 200 is equipped with the latest in design techniques, including advanced 10-bit video digital-to-analog converters (DAC) and Video (composite), S-Video and RGB video (RGB via SCART) outputs, to ensure that you get all the quality inherent in today's DVD medium. For optimum playback of NTSC and PAL DVD with compatible high-definition display devices, the HS 200 is equipped with an HDMI output and progressive scan component video outputs.

Along with conventional Video and CD audio discs, the HS 200 is also compatible with MP3, CD-R and CD-RW as well as DivX® and VCD discs.

NOTE: This player is designed and manufactured for compatibility with Region Management Information that is encoded on most DVD discs. This player is designed only for playback of discs

As portable USB devices increase in popularity, Harman Kardon's HS 200 is among the first integrated home theater system that allows mobile interconnectivity by playing compatible music or image files from portable devices via two USB On-The-Go inputs.

A wide range of programming features makes it easy to program an evening's worth of entertainment. When playing DVDs, easy-to-understand on-screen menus and icons make it simple to change languages, soundtracks, subtitles or aspect ratio, while a parental-lock function enables you to control which discs may be viewed by younger members of the household.

DVD players are among the fastest growing consumer electronics products ever brought to market, but this may, nevertheless, be the first DVD player you've owned. Although many of the features of the DVD resemble those of standard CD players, there are a number of functions that you may be unfamiliar with. To ensure that you are able to take advantage of all the power and flexibility the DVD has to offer, we encourage you to review this quick setup manual. That small investment of your time will pay major dividends in the enjoyment you will get from proper use of the DVD.

with Region Code 2, or for discs that do not contain Region Code information. If there is any other Region Code on a disc, that disc will not play on the DVD.



- **Plays a Wide Range of Video and Audio Formats, Including DVD-Video Discs, VCD, Standard CD Audio Discs, CD-R/RW, DVD-R/RW, DVD-+R/RW, Audio Discs and MP3 Discs**
- **HDMI Output for Digital Audio and Video Connection to an HD-Ready Screen**
- **High-Quality Video Playback 10-Bit DACs, Progressive Scan and Component Video Outputs**
- **Easy-to-Use On-Screen Navigation System**
- **Playback of MP3 and Windows® WMA Audio Discs and JPEG image files**
- **Simultaneous Playback of MP3 and JPEG files**
- **Side- and rear-panel USB On-The-Go connections for playing compatible music or image files from portable devices.**
- **Extensive Programming Capability for Audio and Video Discs**
- **Parental Lock Controls Prevent Unauthorized Viewing of Restricted Movies**
- **Playback of DivX compressed video files**
- **Multiple Options for Language, Soundtrack and Subtitle Selection**
- **Multiple-Angle Capabilities With Specially Encoded DVD Discs**
- **Ergonomically Designed Remote Control**
- **Multiple digital inputs and outputs**
- **Multiple Analog Inputs and Outputs**
- **High Definition On-screen menu and display system**
- **Subwoofer Trigger to Control Subwoofer On/Off**

IMPORTANT NOTES:

This manual should be read in conjunction with the owners manual of the accompanying loudspeaker system. The instructions found therein should be followed with respect to loudspeaker operation and safety.

Only use the HS 200 controller with the loudspeaker system supplied. Failure to do so may cause damage to either the controller or the loudspeakers and will invalidate any warranty.

All of the optional system settings have been preset at our factory for correct operation of the system. All you have to do is insert a disc, sit back, and enjoy a great home theater experience.

You may want to change some of the optional settings. A description of all the optional settings and instructions for changing them are found in the second half of the manual.

Introduction / Safety Information

This system was designed to provide you with many years of reliable operation with a minimum of care and maintenance. Every component in your system was in perfect working condition when it left our factory. If you experience any problems with the set-up or operation of this system, please review the Troubleshooting Guide at the end of this manual before you contact your authorized Harman Kardon dealer.

Important Safety Information

Verify Line Voltage Before Use

Your HS 200 has been designed for use with 220-240-Volt AC current. Connection to a line voltage other than that for which it is intended can create a safety and fire hazard and may damage the unit.

If you have any questions about the voltage requirements for your specific model, or about the line voltage in your area, contact your dealer before plugging the unit into a wall outlet.

Do Not Use Extension Cords

To avoid safety hazards, use only the power cord attached to your unit. We do not recommend that extension cords be used with this product. As with all electrical devices, do not run power cords under rugs or carpets or place heavy objects on them. Damaged power cords should be replaced immediately by an authorized service depot with a cord meeting factory specifications.

Handle the AC Power Cord Gently

When disconnecting the power cord from an AC outlet, always pull the plug, never pull the cord. If you do not intend to use the unit for any considerable length of time, disconnect the plug from the AC outlet.

Do Not Open the Cabinet

There are no user-serviceable components inside this product. Opening the cabinet may present a shock hazard, and any modification to the product will void your guarantee. If water or any metal object such as a paper clip, wire or a staple accidentally falls inside the unit, disconnect it from the AC power source immediately, and consult an authorized service station.

Installation Location

- To assure proper operation and to avoid the potential for safety hazards, place the unit on a firm and level surface. When placing the unit on a shelf, be certain that the shelf and any mounting hardware can support the weight of the product.
- Make certain that proper space is provided both above and below the unit for ventilation. If this product will be installed in a cabinet or other enclosed area, make certain that there is sufficient air movement within the cabinet. Under some circumstances a fan may be required.
- Do not place the unit directly on a carpeted surface.
- Avoid installation in extremely hot or cold locations, or an area that is exposed to direct sunlight or heating equipment.
- Avoid moist or humid locations.
- Do not obstruct the ventilation slots on the top of the unit, or place objects directly over them.

Cleaning

When the unit gets dirty, wipe it with a clean, soft, dry cloth. If necessary, wipe it with a soft cloth dampened with mild soapy water, then a fresh cloth with clean water. Wipe dry immediately with a dry cloth. NEVER use benzene, aerosol cleaners, thinner, alcohol or any other volatile cleaning agent. Do not use abrasive cleaners, as they may damage the finish of metal parts. Avoid spraying insecticide near the unit.

Moving the Unit

Before moving the unit, be certain to disconnect any interconnection cords with other components, and make certain that you disconnect the unit from the AC outlet.

Unpacking

The carton and shipping materials used to protect your new receiver during shipment were specially designed to cushion it from shock and vibration. We suggest that you save the carton and packing materials for use in shipping if you move, or should the unit ever need repair.

To minimize the size of the carton in storage, you may wish to flatten it. This is done by carefully slitting the tape seams on the bottom and collapsing the carton. Other cardboard inserts may be stored in the same manner. Packing materials that cannot be collapsed should be saved along with the carton in a plastic bag.

If you do not wish to save the packaging materials, please note that the carton and other sections of the shipping protection are recyclable. Please respect the environment and discard those materials at a local recycling center.

Copyright

Audio-visual material may consist of copyright works which must not be recorded without the permission of the owner of the copyright. Please refer to relevant laws covering copyright protection.

Copy protection

This DVD player supports Macrovision copy protection. On DVD discs that include a copy protection code, if the contents of the DVD disc are copied using a VCR, the copy protection code prevents the videotape copy from playing normally.

For Optimum Performance

The controller is a precision device that is constructed using extremely accurate technology. Soiling or friction affecting the pickup lens or disc drive can impair the image quality. In the worst case, neither video nor audio will be played back. To obtain optimum picture quality, the player should be checked (cleaning and replacement of some parts) every 1,000 hours. Note that this period varies depending on the environment (temperature, humidity, dust) in which the player is used.

Do not attempt to clean the pickup lens yourself.



CAUTION
RISK OF ELECTRIC SHOCK
DO NOT OPEN



CAUTION: TO REDUCE THE RISK OF ELECTRIC SHOCK, DO NOT REMOVE COVER (OR BACK). NO USER-SERVICEABLE PARTS INSIDE. REFER SERVICING TO QUALIFIED SERVICE PERSONNEL.



The lightning flash with arrowhead symbol, within an equilateral triangle, is intended to alert the user to the presence of uninsulated "dangerous voltage" within the product's enclosure that may be of sufficient magnitude to constitute a risk of electric shock to persons.



The exclamation point within an equilateral triangle is intended to alert the user to the presence of important operating and maintenance (servicing) instructions in the literature accompanying the appliance.

WARNING: TO REDUCE THE RISK OF FIRE OR ELECTRIC SHOCK, DO NOT EXPOSE THIS APPLIANCE TO RAIN OR MOISTURE.

Terminology

Terminology

Since they share some of the characteristics and technology of CD players, many of the terms and operational concepts used in a DVD player are similar to what you may be familiar with from CD players and changers, or older video disc formats such as Laser Disc. However, if this is your first DVD product, some of the terms used to describe the features of a DVD player may be unfamiliar. The following explanations should solve some of the mysteries of DVD, and help you to enjoy all the power and flexibility of the DVD format and the DVD.

With the arrival of DVD, disc data capacity has increased dramatically. On a DVD Video disc most of this capacity is taken up by MPEG 2 video and the multichannel movie soundtrack in Dolby Digital and/or DTS.

This information is compressed.

Aspect Ratio: This is a description of the width of a video image in relation to its height. A conventional video screen is four units wide for every three units of height, that's why the ratio is called "4:3". Newer wide aspect ratio video displays are 16 units wide for every nine units of height, making them more like the screen in a movie theater. The program material on a DVD may be recorded in either format and, in addition, you may configure the DVD to play back in either format, depending on the features recorded on a disc.

High Definition Multimedia Interface

(HDMI): HDMI has emerged as the digital standard for connecting High Definition devices, displays and components, and provides for the pristine transmission of high-definition digital video and digital audio via a single cable. HDMI is the first and only digital interface for Consumer Electronics devices that can carry uncompressed high-definition video, compressed or uncompressed multi-channel audio and command data, allowing customers to obtain pure digital picture and sound directly from the source (as it was meant to be seen and heard).

USB On-The-Go: Due to its widespread acceptance, USB is becoming the de facto industry standard for connecting peripherals to PCs and laptops. Many of the new peripherals using USB are also portable devices.

As these portable devices increase in popularity, there is a growing need for them to communicate directly with each other when a PC is not available, for instance in consumer electronics products. The USB On-The-Go technology addresses this need for mobile interconnectivity.

Title: For a DVD, a title is defined as an entire movie or program. There can be as many chapters within a title as the producers decide to include. Most discs include only one title, but some may have more than one, to give you a "Double Feature" presentation.

Chapter: DVD programs are divided into chapters and titles. Chapters are the sub-sections programmed into a single title on a disc. Chapters may be compared to the individual tracks on an audio CD.

RGB Video: This is a new form of video signal that eliminates many of the artifacts of traditional composite video signals by splitting the signal into the three fundamental colors Red, Green and Blue (RGB). With an RGB connection (via SCART), you will see greater picture resolution and eliminate many picture imperfections such as the moiré patterns often seen on checkered patterned cloths. However, in order to benefit from RGB video, you must have a video display with an RGB compatible SCART input.

Progressive scan: DVD offers progressive scan video outputs for use with compatible high-resolution televisions and projectors. Before DVD, no consumer medium could store, transmit or display video with full resolution. To conserve bandwidth, analog compression (interlacing) is employed: first the odd-numbered lines of a frame are displayed, followed by the even-numbered lines. The result is that only half of the video image is drawn at one time; the viewer's brain must reassemble the complete image. This is acceptable, if the monitor is not too large and if there is not too much motion in the image. Large displays and fast-moving images reveal the limitations of this system. Thanks to DVD's immense data capacity, images are now stored intact (progressively), so that all the lines in each frame (odd and even) are shown at the same time. But because most TV's cannot handle a progressive signal, all current DVD players generate an interlaced output for compatibility. Now, the Harman Kardon DVD is among the select few DVD players with true progressive scan video output (NTSC and PAL) for use with compatible TV's and CRT projectors and with all plasma, LCD and DLP display devices via the component video output. The result is 40% greater light output than a conventional TV and a stunningly detailed high definition image, along with an almost complete absence of visible scanlines and motion artifacts. Of course, traditional Y/Pr/Pb component video, SCART, S-Video and composite video outputs are included for use with conventional televisions and projectors.

Multiple Angle: DVDs have the capability to show up to four different views of the same scene in a program. When a disc is encoded with multiple-angle information, pressing the Angle button will enable you to switch between these different views. Note that at present, few discs take advantage of this capability and, when they do, the multiple-angle technology may only be present for short periods of time within the disc. Producers will usually insert some sort of icon or graphic in the picture to alert you to the availability of multiple viewing angles.

Reading: This is a message that you will see after you've loaded the disc and the tray has closed. It refers to the fact that the player must first examine the contents of the disc to see if it is a CD or DVD, and then extract the information about the type of material on the disc, such as languages, aspect ratios, subtitles, number of titles and more. The slight delay while the contents of the disc are read is normal.

Resume: The operation of the Stop Button on the DVD works differently from what you are used to on CD players. On a traditional CD player, when you press the Stop button, the unit does just that: it stops playback. On a CD player, when you press the start button again, the disc starts from the beginning. With the DVD, however, you have two options when playing DVD discs. Pressing Stop once will stop playback, but it actually puts the unit in the Resume mode. This means that you can turn the machine off and, when you press play the next time, the disc will resume or continue from the point on the disc where the Stop button was pressed. This is helpful if you are watching a movie and must interrupt your viewing session but wish to pick up where you left off. Pressing the Stop button twice will stop the machine in a traditional manner and, when the disc is played again, it will start from the beginning.

In resume mode, the cover of the DVD will be displayed, if available. Otherwise, the Harman Kardon screen will appear.

DivX

DivX is the name of a revolutionary new video codec which is based on the MPEG-4 compression standard for video. This DVD player will playback discs created with DivX software. The DVD player's playback functionalities of DivX video discs will vary depending on the DivX software version used for creating your movies. For more information about the different software versions of DivX, please go to www.divx.com

Features

High quality video

- High Definition Multimedia Interface (HDMI) for a single wire, digital connection to your HD-Ready screen.
- Advanced sophisticated 10-bit MPEG-2 video decoding circuits.
- Progressive Scan component video outputs (NTSC and PAL)
- Direct RGB output via SCART (selectable) for optimum video performance when HDMI or component video connections are not available. SCART connector also configurable for Composite Video output.
- Test screen videos available for testing video performance and setup.
- Pure PAL with NTSC disc due to true NTSC/PAL conversion.
- Dual-layer compatibility for extended play DVD.
- Playback of JPEG image files

High quality digital audio

- High quality 2.1 digital surround sound from DTS or Dolby Digital discs.
- With linear PCM audio at 16-24 bits and 44-96 kHz, audio quality exceeding that of CD becomes possible.
- Coaxial digital audio output.

Many convenient features

- On-Screen Menu Icons for disc information or player information and access to many major functions of this unit.
- Thumbnails for easy search of image files.
- Subtitles may be displayed in one of numerous languages*.
- The multi-angle function allows you to choose the viewing angle of scenes which were shot from a number of different angles (Limited to DVD's recorded with multiple camera angles.)
- Multiple options for dialog language and soundtrack selection (limited to DVD's recorded with multiple dialog languages or soundtracks).
- Intuitive menu operating system.
- 4 step Zoom during play and pause.
- Backlit, ergonomically designed remote control.
- Future software upgrades accessible via Internet. (See information below.)

* The number of languages recorded depends on the software.

Compatible with CD as well as DVD

- The HS 200 will play any conventional Audio CD or recordable (CD-R) or erasable CD (CD-RW), MP3, WMA (v9) or any DivX or VCD or DVD-Video with the region code 0 or 2.

Disc formats supported by this player

The unit can play the following disc formats (8 cm and 12 cm size):

- DVD
- DVD-R
- DVD-RW
- DVD+R
- DVD+RW
- CD
- CD-R
- CD-RW
- VCD
- S-VCD
- WMA (v9)

NOTE: Due to differences in the format of certain discs, it is possible that some discs may include a mix of features that are not compatible with the DVD. Similarly, although the DVD is capable of a wide range of features, not all discs include every capability of the DVD system. For example, although the DVD is compatible with multi-angle discs, that feature is only possible when the disc is specially encoded for multiple-angle play. In addition, the DVD is capable of playing back both Dolby Digital and DTS soundtracks, but the number and types of tracks available will vary from disc to disc. To make certain that a specific feature or soundtrack option is available, please check the options noted on the disc jacket.

- Playback capability for CD-R, CD-RW, WMA, JPEG, MP3, DivX, VCD/SVCD, DVD-R, DVD+R, DVD-RW and DVD+RW discs may vary due to variations in the quality of the disc and the recorder used to create the disc.

- The HS 200 is compatible with most discs recorded with files encoded using MP3 or Windows Media 9, as well as JPEG still images. However, note that variations in the encoder or codec used and the bit rate of the encoding may affect the HS's ability to play back a specific disc. As a result, we cannot guarantee complete compatibility with all encoders and versions of the codecs. For best results, we recommend that MP3 files be encoded at bit rates ranging between 32 kbps and 320 kbps. WMA files should be encoded at bit rates between 64kbps and 320 kbps. Although the HS systems is capable of playing some WMA 9 files, not all features of version 9 are supported. JPEG files should contain no more than 5 megapixels, and the file size should be no larger than 5 Mb.

Upgradeability via Internet

The "firmware" controlling the functionality of the Harman Kardon HS system is fully upgradeable. In the event of future improvements to its operations and features, it will be possible to download firmware upgrades from

www.harmankardon.com/International/

All you have to do is create a CD-R with the data and insert it in the DVD for an automatic upgrade.

Packing List

- 1 Harman Kardon HS 200 DVD Player/Controller
- 1 Harman Kardon HKTS 2 Home Theater Speaker System
- 1 Harman Kardon HTFS 2 Loudspeaker stands
- 1 Remote control
- 3 AAA batteries
- 1 A/V cable for stereo analog audio and composite video
- 1 S-Video cable
- 1 remote extension cable
- 1 owner's manual

Front Panel Controls

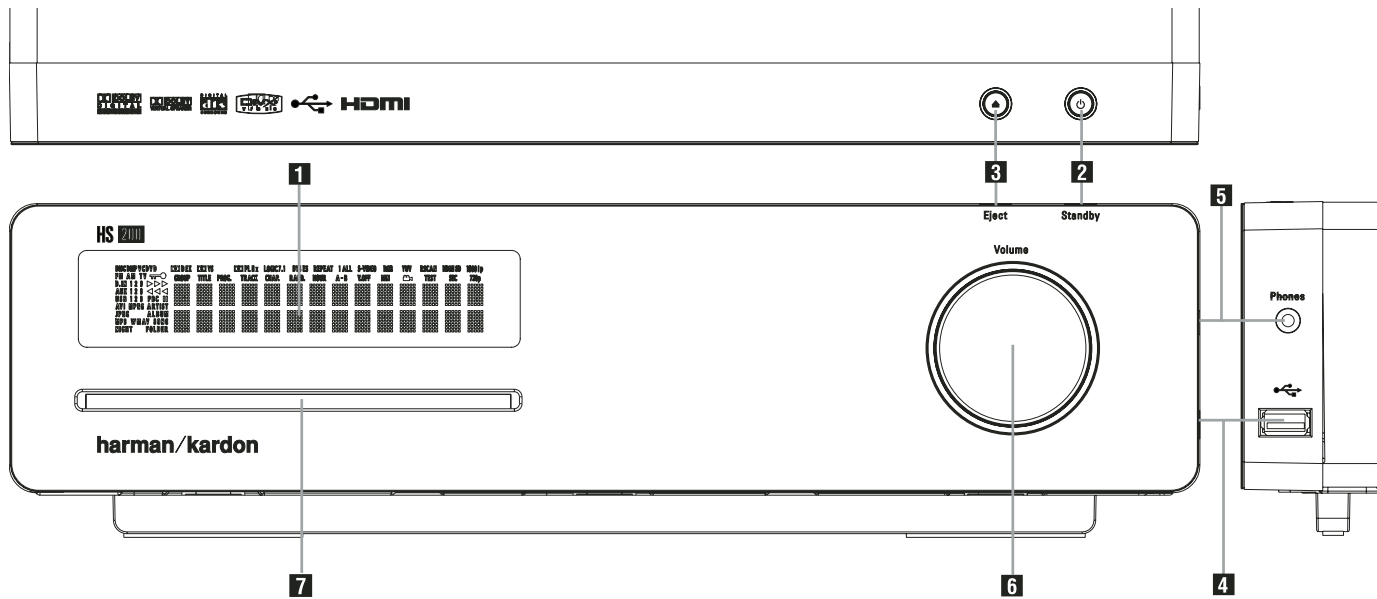

- 1** Main Information Display
- 2** Power On/Off (Standby)
- 3** Eject

- 4** USB On-The-Go Input
- 5** Headphone Jack
- 6** Volume Control

- 7** Slot Loader

1 Main Information Display: This display delivers messages and status indications to help you operate the HS 200 Controller.

2 Power On/Off (Standby): Press the button once to turn the HS 200 Controller on, press it again to put the unit in the Standby mode. Note that when the HS 200 Controller is switched on, the Power Indicator around the button turns blue.

3 Eject: Press this button to release a disc from the loader.

4 USB On-The-Go Input: This input may be used to temporarily connect a USB thumb device or portable hard disk for direct playback of audio, image or video files or a USB hub. The USB inputs are designed to power a single USB device at a time. If additional hard disks are connected through a hub it is necessary that additional external power supplies are used to power the hub and hard disks.

5 Headphone Jack: This jack may be used to listen to the system's output through a pair of headphones. Be certain that the headphones have a standard 3.5 mm stereo phone plug. Note that the main room speakers will automatically be turned off when the headphone jack is in use.

6 Volume Control: Turn this knob clockwise to increase the volume, counterclockwise to decrease the volume. If the system is muted, adjusting volume control will automatically release the unit from the silenced condition.

7 Slot loader: Gently insert a CD or DVD into this slot, with the printed side of the disc facing up. Note there is no drawer. Press the **Eject Button 3** to release the disc.

Front Panel Display

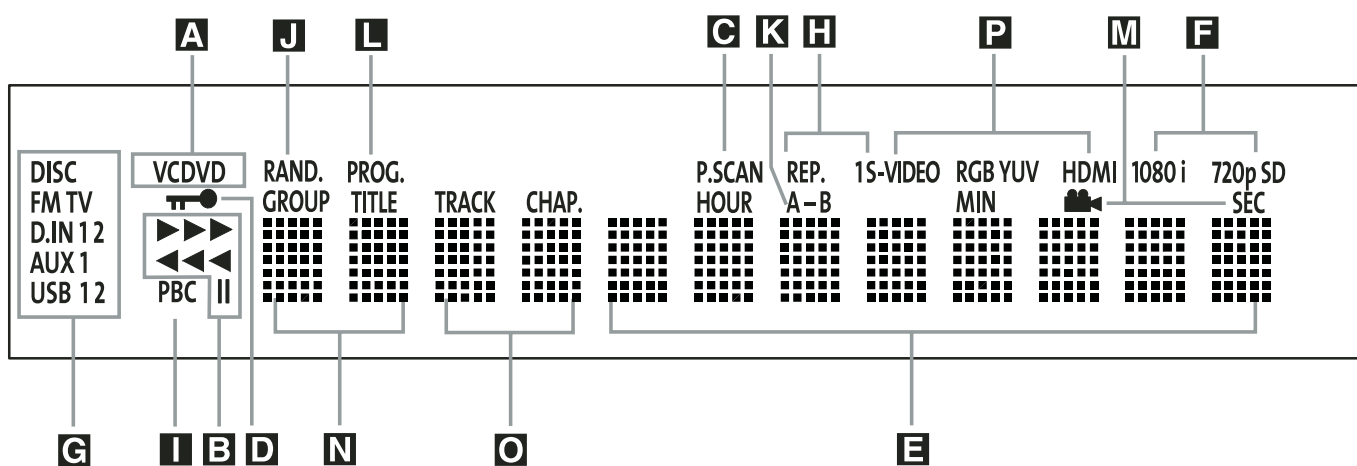

- A** Disc Type Indicators
- B** Playback-Mode Indicators
- C** Progressive Scan Indicator
- D** Parental Lock Indicator
- E** Time Indicators
- F** Video Format Indicators

- G** Source Indicators
- H** Repeat Indicators
- I** VCD Playback Control Indicator
- J** Random Indicator
- K** A-B Repeat Indicator
- L** Program Indicator

- M** Angle Indicator
- N** Title Indicators
- O** Chapter/Track Number Indicators
- P** Video Output Indicators

A Disc Type Indicators: The CD or DVD indicator will illuminate to show the type of disc currently being played.

B Playback-Mode Indicators: These indicators light to show the current playback mode:

- ▶ Lights when a disc is playing in the normal mode
- ▶▶ Lights when the disc is in the Fast Search Forward mode. The on-screen banner display indicates the selected speed (2x, 8x, 16x, 100x).
- || Lights when the disc is paused.
- ◀◀ Lights when the disc is in the Fast Search Reverse mode. The on-screen banner display indicates the selected speed (2x, 8x, 16x, 100x).

C Progressive Scan Indicator: This indicator lights when the unit sends out a progressive scan signal.

D Parental Lock Indicator: This indicator lights when the parental-lock system is engaged in order to prevent anyone from changing the rating level without a code.

E Time Indicators: These positions in the indicator will show the running time of a DVD in play. When a CD is playing, these indicators will show the current track time, time remaining in the current track, or the total remaining time on the disc.

NOTE: The Indicators **NOE** will also display text messages about the DVD's status, including **Reading** when a disc is loading, **STANDBY** when the unit is turned off, and **Disc Error** when a disc not compatible with the DVD is put into the play position.

F Video Format Indicators: These indicators will represent the video format currently playing.

G Source Indicators: These indicators will light to show which source is currently selected.

H Repeat Indicators: These indicators light when any of the Repeat functions are in use.

I VCD Playback Control Indicator: This indicator lights when the playback control function is turned on with VCDs.

J Random Indicator: This indicator lights when the unit is in the Random Play mode.

K A-B Repeat Indicator: This indicator lights when a specific passage for repeat playback has been selected.

L Program Indicator: This indicator lights when the programming functions are in use.

M Angle Indicator: This indicator blinks when alternative viewing angles are available on the DVD currently playing.

N Title Indicators: These two positions in the display will show the current title number when a DVD disc is playing.

O Chapter/Track Number Indicators: When a DVD disc is playing, these two positions in the display will show the current chapter. When a CD disc is playing they will show the current track number.

P Video Output Indicators: These indicators will represent the active video output.

Rear Panel Connections

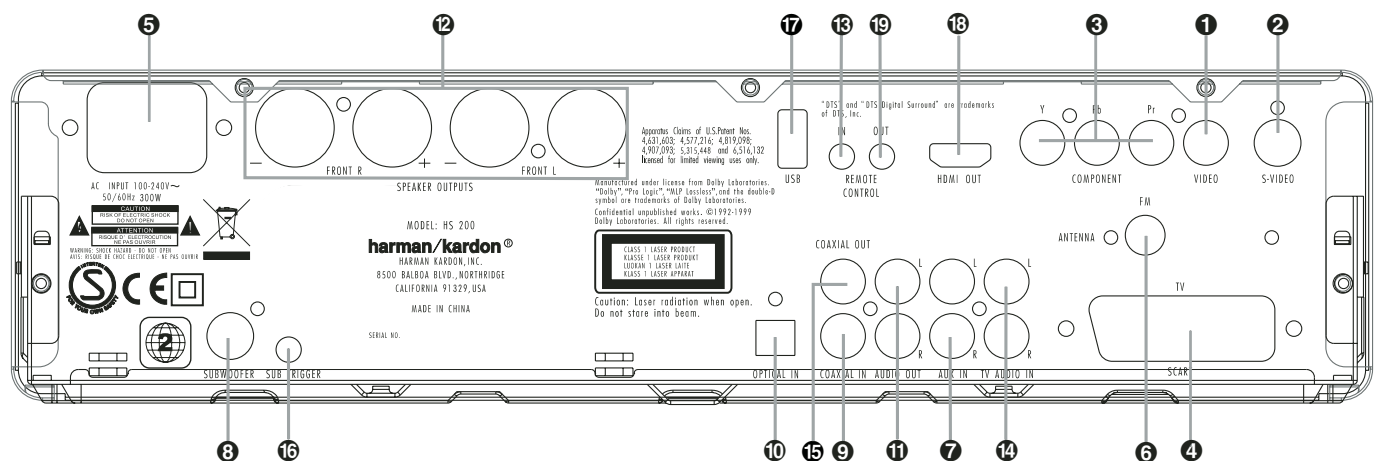

- 1 Composite Video Output
- 2 S-Video Output
- 3 Component Video Outputs
- 4 Scart TV Output
- 5 AC Power Cord
- 6 FM Antenna
- 7 Audio In
- 8 Subwoofer Output
- 9 Coaxial Digital Input
- 10 Optical Digital Input
- 11 Analog Audio Outputs
- 12 Front Speaker Outputs
- 13 Remote IR Input
- 14 TV Audio In
- 15 Coaxial Digital Output
- 16 Subwoofer Trigger Output
- 17 USB On-The-Go Input
- 18 HDMI Output
- 19 Remote IR Output

1 Composite Video Output: Connect this jack to the video input on a television or video projector.

2 S-Video Output: Connect this jack to the S-Video input on a television or video projector.

3 Component Video Outputs: These outputs carry the component video signals for connection to display monitors with component video inputs. For standard analog TV's or projectors with inputs marked Y/Pr/Pb or Y/Cr/Cb, connect these outputs to the corresponding inputs. If you have a high-definition television or projector that is compatible with high scan rate progressive video, connect these jacks to the "HD Component" inputs. Note that if you are using a progressive scan display device, then "Progressive" must be selected in the Video Set-up Menu in order to take advantage of the progressive scan circuitry. See page 20 for more information on progressive scan video.

IMPORTANT: These jacks should NOT be connected to standard composite video inputs.

4 SCART OUT (TV): If your TV has a SCART socket, you can connect a SCART cable to your TV and to your DVD Player for improved video quality. The SCART cable carries both audio and video. You can select Composite Video or RGB video for that SCART connector's video output signal.

5 AC Power Cord: Connect this plug to an AC outlet. If the outlet is controlled by a switch, make certain that it is in the ON position.

6 FM Antenna: Connect to the supplied FM antenna.

7 Audio In: Connect to a line-level analog audio source: TV, tape player, Minidisc, PC, etc.

8 Subwoofer Output: Connect to the SUB/LFE input on the subwoofer.

9 Coaxial Digital Input: Connect the coax digital output from a DVD player, HDTV receiver, LD player, MD player, satellite receiver or CD player to this jack. The signal may be either a Dolby Digital signal, DTS signal or a standard PCM digital source. Do not connect the RF digital output of an LD player to these jacks.

10 Optical Digital Input: Connect the optical digital output from a DVD player, HDTV receiver, LD player, MD player, satellite receiver or CD player to this jack. The signal may be either a Dolby Digital signal, DTS signal or a standard PCM digital source.

11 Analog Audio Outputs: Connect these jacks to the analog audio input on a TV set or external audio system for analog audio playback or to the RECORD/INPUT jacks of an audio recorder for recording.

12 Front Speaker Outputs: Connect these outputs to the matching + or – terminals on your left and right speakers. In conformance with the new CEA color code specification, the White terminal is the positive, or "+" terminal that should be connected to the red (+) terminal on Front Left speaker with the older color coding, while the Red terminal is the positive, or "+" terminal that should be connected to the red (+) terminal on Front Right speaker. Connect the black (–) terminals on the HS to the black (–) terminals on the speakers. See page 14 for more information on speaker polarity.

13 Remote IR Input: If the HS 200's front-panel IR sensor is blocked due to cabinet doors or other obstructions, an external IR sensor may be used. Connect the output of the sensor to this jack.

Rear Panel Connections

14 TV Audio Input: If your screen is connected to the HS by an HDMI, Component, S-Video or Composite cable, connect the analog output of your TV to this input. If you have your TV connected to the HS with a Scart cable, an audio connection to the TV Input is not necessary.

Note: You'll find more details about all Audio/Video connections under Setup and Connections on the following pages.

15 Coaxial Digital Output: Connect this jack to the matching digital input connector on a digital recorder such as a CD-R or MiniDisc recorder.

16 Subwoofer Trigger Output: Connect this trigger output to the trigger input of the Harman Kardon subwoofer, so that the subwoofer will switch on and off at the same time as the rest of the system.

17 USB On-The-Go Input: This input may be used to temporarily connect a USB thumb device or portable hard disk for direct playback of audio, image or video files, a digital photo camera or a USB hub.

18 HDMI Output: Connect this output to the HDMI input of high-definition LCD, Plasma or video projector for the best possible picture quality.

19 Remote IR Output: This connection permits the IR sensor in the receiver to serve other remote controlled devices. Connect this jack to the "IR IN" jack on Harman Kardon or other compatible equipment.

Remote Control

- 1 Power On/Source Selection Button
- 2 Power Off Button
- 3 Subtitle Button
- 4 Title Button
- 5 Angle Button
- 6 Audio Button
- 7 Enter Button
- 8 Eject Button
- 9 Set-Up/OSD Button
- 10 Arrows Button
- 11 Mute Button
- 12 Menu Button
- 13 Pause Button
- 14 Status Button
- 15 Skip/Step (Previous) Button
- 16 Skip/Step (Next) Button
- 17 Play Button
- 18 Search/Slow Reverse Button
- 19 STOP Button
- 20 Search/Slow Forward Button
- 21 Macro Buttons
- 22 Pic +/Pic - Button
- 23 Zoom Button
- 24 Playlist Button
- 25 Random Button
- 26 A-B Repeat Button
- 27 Volume up/down Button
- 28 Light Button
- 29 Numeric Keys Button
- 30 Repeat Button
- 31 Clear Button
- 32 Video output Button
- 33 Video format Button
- 34 Learn Button
- 35 Screen Power Buttons
- 36 Info Button
- 37 Teletext Buttons
- 38 Picture in Picture Button
- 39 Screen Format Button
- 40 IR Transmitter Window
- 41 Program Indicator
- 42 Mode Button

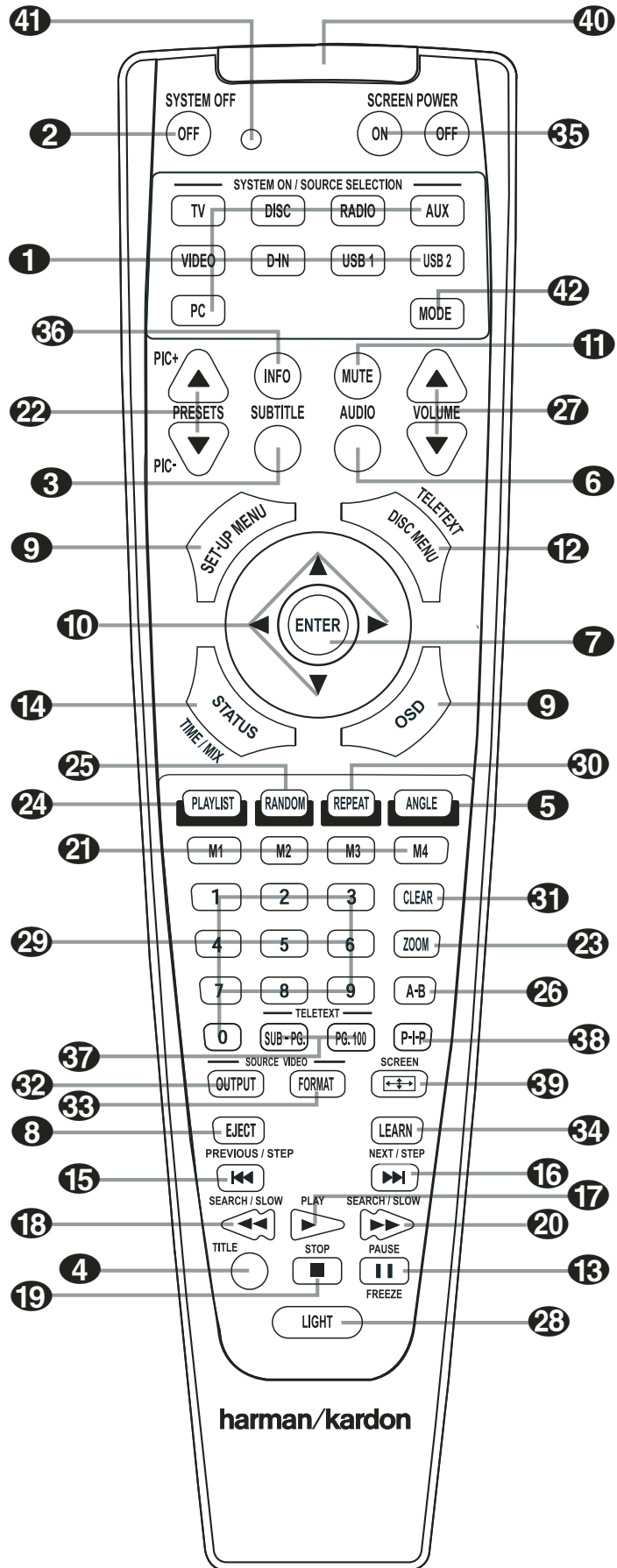

Remote Control

1 Power On/Source Selector Buttons:

Pressing one of these buttons will perform three actions at the same time. First, if the HS System is not turned on, this will power up the unit. Next, it will select the source shown on the button as the input to the HS System. Finally, it will change the remote control so that it controls the device selected.

2 Power Off Button: Turns off the HS system to standby mode.

3 Subtitle Button: When a DVD is playing, press to select a subtitle language or to turn subtitles off.

4 Title Button: When a disc is playing, press to make the player go back to the first section of the disc.

5 Angle Button: Press to access various camera angles on a DVD (If the DVD contains multiple camera angles) or to rotate JPEG images.

6 Audio Button: Press to access various audio languages on a DVD (If the DVD contains multiple audio streams).

7 Enter Button: Press this button to activate a setting or option.

8 Eject Button: Press to release the disc from the loader.

9 Set-up/OSD: Press to access the On Screen Display Menu.

10 Arrow buttons (◀/▶/▲/▼) Buttons: Use to move the cursor in the OSD.

11 Mute Button: Mutes the sound.

12 Menu Button: Displays the actual DVD Disc Menu on the TV screen in play mode. When playing discs with JPEG images, pressing this button will access the thumbnails.

13 Pause Button: Freezes a picture (with DVD/VCD) and pauses the playback signal (CD) when a disc is playing. Press again for normal playback.

14 Status Button: Press while a disc is playing to view banner display. Use the ARROW buttons to move through the different features in the Banner Display. When a symbol is highlighted, press ENTER on the remote to select it.

15 Skip/Step (Previous) Button: Press to go to beginning of current track. Press again quickly to go to beginning of previous track. After pressing the PAUSE button, each press of this button will move the image in reverse frame by frame.

16 Skip/Step (Next) Button: Press to go to beginning of next track. After pressing the PAUSE button, each press of this button will move the image forwards frame by frame.

17 Play Button: Begins to play disc (closes disc tray first, if it is open).

18 Search/Slow (Rev.) Button: Allows you to search in reverse through a disc while it is in play mode. Each time you press this button, the search speed changes as indicated by a number of arrows on the right top of your screen. After pressing the PAUSE button, each press of this button will change the slow down speed indicated by a number of arrows in the right top of the screen.

19 Stop Button: Stops playing a disc. When a disc is playing, if you press STOP and PLAY, the disc will resume play, i.e. it will start from the same point on the disc where the unit was stopped. If you press STOP twice and the PLAY button, the disc will start play from the beginning.

20 Search/Slow (Fwd.) Button: Allows you to search forward through a disc while it is in play mode. Each time you press this button, the search speed changes as indicated by a number of arrows on the right top of your screen. After pressing the PAUSE button, each press of this button will change the slow down speed as indicated by a number of arrows in the right top of the screen.

21 Macro Buttons: Press these buttons to store or recall a "Macro", which is a pre-programmed sequence of commands stored in the remote. (See page 26 for more information on storing and recalling macros.)

22 Pic +/Pic - Button: Pressing these buttons in JPEG mode will move to the previous or next image.

23 Zoom Button: When a DVD or VCD is playing, press this button to zoom the picture so that it is enlarged. There are 4 steps to the zoom function, each progressively larger. Press through each of the zoom stages to return to a normal picture. The Zoom function is not available when watching High Definition material.

24 Playlist Button: Press this button to change the playback order of the disc.

25 Random Button: Press for RANDOM playback in random order.

26 A-B Button: Press to select section A-B and to play repeatedly.

27 Volume Up/Down: Increase/decrease the master volume level.

28 LIGHT Button: Press to illuminate remote controller.

29 Numeric Keys Button: Select numbers by pressing these buttons.

30 Repeat Button: Press to go to the Repeat menu. You can repeat a chapter, track or the entire disc.

31 Clear Button: Press to remove the Banner menu from the screen.

32 Video output Button: Press to toggle between the S-Video, Component Video Outputs and SCART RGB video output of the HS System player. Note that the Composite and SCART Composite Video Outputs on the player are always active, which could help you make your initial setup.

33 Video format Button: Press this button to change the resolution of the Component Video Output between standard definition and progressive definition (PAL interlaced and PAL progressive; NTSC interlaced and NTSC progressive).

34 Learn Button: Press this button to begin the process of "learning" the codes from another product's remote into the HS System's remote. (See page 26 for more information on using the remote's learning function.)

35 to 39 These buttons do not have a direct function with the HS 200, but can be programmed to control some of the functions of your TV using the Learning function of the remote control.

40 IR Transmitter Window: Point this window towards the HS when pressing buttons on the remote to make certain that infrared commands are properly received.

41 Program Indicator: This three-color indicator is used to guide you through the process of learning commands from a remote into the HS's remote code memory. (See page 26 for more information on programming the remote.)

42 Mode Button: This button enables you to switch the remote to another mode so that it operates another device without selecting it as the source. Each press of the Mode button changes the remote's mode in this order: TV, DVD, CD, RADIO, AUX, D-IN, USB 1 and USB 2, and then back to TV again. The corresponding Source Selector will light to indicate the mode.

Basic Information

About This Manual

- The types of functions and operations that can be used for a particular disc vary depending on the features of that disc. In some cases, these functions and operations may differ from the descriptions given in this manual. In this event, follow the instructions given on the screen. This manual only covers basic disc operations.
- For some operations, the  icon may appear on the screen. This indicates that the operation described in this manual is not available on the disc in the player.
- On-screen and front panel display illustrations in this manual are purely for the purposes of explanation. The actual displays may differ slightly from these illustrations.

Disc handling precautions

- To keep the disc clean, handle the disc by its edge. Do not touch the surface.
- Do not stick paper or tape on the disc. If there is glue (or a similar substance) on the disc, remove the glue completely before using the disc.

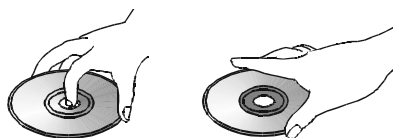

- Do not expose the disc to direct sunlight or sources such as hot air ducts, or leave it in a car parked in direct sunlight as there can be a considerable rise in temperature inside the car.
- After playing, store the disc in its case.
- Do not write on the label side with a ball-point pen or other writing utensils.
- Be careful not to drop or bend the disc.

Disc cleaning precautions

- Before playing, clean the disc with a cleaning cloth. Wipe the disc from the center out.
- Do not use solvents such as benzine, thinner, commercially available cleaners or anti-static spray intended for vinyl LPs.

Disc installing precautions

- Do not install more than 1 disc into the loader.
- Do not place the disc up-side down.
- Hold the disc horizontally when loading, and do not press extensively. The disc loading mechanism should take the disc and slide it into the unit.

Regional Coding

DVD players and discs are designed with regional restrictions which dictate the regions in which a disc can be played. If the region number on the disc you want to play does not match the region number of your DVD player, you will not be able to play the disc. The message "REGION ERR" will appear in the front panel display. The region code of this player is indicated on the rear and on the external packaging.

Installation and Connections

After unpacking the unit, and placing it on a solid surface capable of supporting its weight, you will need to make the connections to your audio and video equipment.

Audio Equipment Connections

We recommend that you use high-quality interconnect cables when making connections to source equipment and recorders to preserve the integrity of the signals.

When making connections to audio source equipment or speakers it is always a good practice to unplug the unit from the AC wall outlet. This prevents any possibility of accidentally sending audio or transient signals to the speakers that may damage them.

1. Connect the front speaker outputs **12** to the respective speakers.

Cables that are run inside walls should have the appropriate markings to indicate listing with any appropriate testing agency standards. Questions about running cables inside walls should be referred to your installer or a licensed electrician who is familiar with the applicable local building codes in your area.

When connecting wires to the speakers, be certain to observe proper polarity. Note that the positive (+) terminal of each speaker connection now carries a specific color code. However, most speakers will still use a red terminal for the positive (+) connection. Connect the "negative" or "black" wire to the same terminal on both the receiver and the speaker.

We also recommend that the length of cable used to connect speaker pairs be identical. For example, use the same length piece of cable to connect the front-left and front-right speakers, even if the speakers are a different distance from the HS controller.

2. Connections to the subwoofer are made via a line level audio connection from the **Subwoofer Output 8** to the line-level SUB input (purple) of the subwoofer. Connect at the same time the **Subwoofer Trigger Output 16** to the Trigger Input of the subwoofer.
3. Connect the supplied FM antenna to the **FM (75 ohm) connection 6**. The FM antenna may be an external roof antenna, an inside powered or wire lead antenna or a connection from a cable system. Note that if the antenna or connection uses 300-ohm twin-lead cable, you should use a 300-ohm-to-75-ohm adapter to make the connection.

Video Equipment Connections

Video equipment is connected in the same manner as audio components. Again, the use of high-quality interconnect cables is recommended to preserve signal quality.

Connecting the TV and optional components

NOTE: To be able to listen to the sound of a live TV show through the loudspeakers of your HS system you need a connection between the audio output of your TV and the HS controller: to achieve this when using the supplied SCART cable, you don't need to connect any additional wires – the SCART cable transports audio and video signals in both directions. But when using the HDMI, Component, S-Video or composite jacks you need to connect the audio output of your TV set with the **TV AUDIO IN 21** on the back of your HS controller. If your TV has a digital audio output, it is recommended to use that one over the analog audio output. Connect the digital output of your TV to the **DIGITAL IN 9/10** on the back of your HS Controller.

HDMI Connection

If your TV set is equipped with an HDMI input, we suggest you use the HDMI connection to connect your HS system and your TV. It will allow you to watch your DVD's in the best possible picture quality. Most LCD, Plasma and video projectors have such an HDMI input nowadays. Connect the **HDMI Output 18** to the HDMI Input of your video device.

The HDMI wire does not transport audio signals from the TV to the HS, thus you need an additional audio connection (see note above).

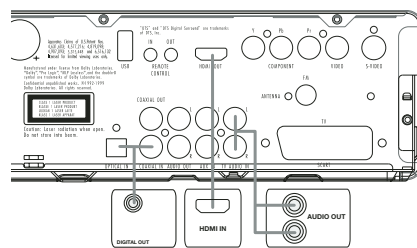

If your TV set does not have an HDMI Input, please follow one of the steps below to connect it to your HS system or other video components.

TV Connection (method 1) – using SCART cable (included)

To view the video from DVD discs on your TV set, connect the SCART TV Out jack **4** of the HS system to the SCART In jack of your TV set. The audio connection runs through the same cable (see note above).

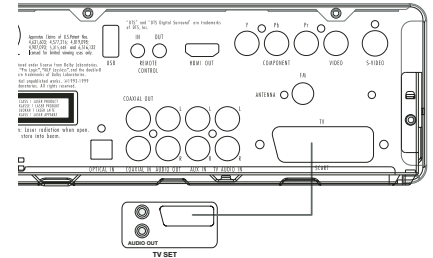

TV Connection (method 2) – using S-Video cable (not included)

If your TV set has an S-Video input jack you can connect your TV to the S-Video out jack **2** on the back of the HS controller. S-Video wires don't transport audio signals, thus you need an additional audio connection (see note above).

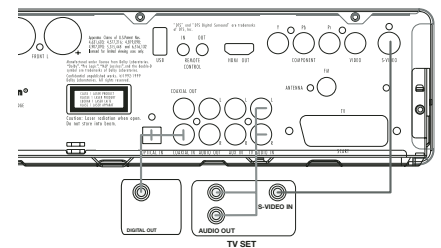

TV connection (method 3) – using composite video (cable not included)

If your TV set has neither S-Video nor SCART input jacks, connect the Video Out jack **1** of the HS to the Video In jack of your TV set. The composite wire also doesn't transport audio signals, thus you need to make additional connections (see earlier note).

Component Video Connection (method 4)

If the video display has component video inputs, connect the Component Video Outputs **3** on the HS 200 to the corresponding input jacks on your television. If you are using a progressive scan television or projector, you must also change the Scan Type in the DVD player's Video Set-Up Menu from "Interlaced" to "Progressive".

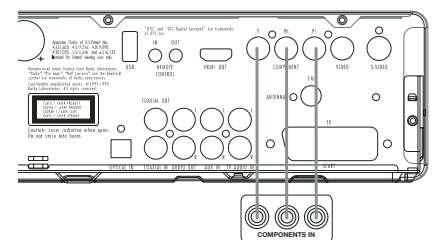

Installation and Connections

Connecting VCR and Sat Decoder (method 5 and 6)

Diagrams 5 and 6 show possible connection methods for common system configurations. These are intended as guidelines only. Due to differences in equipment specifications, the method of connection of your equipment may be different to that shown. Please consult the Owner's Manual of your equipment for further guidance.

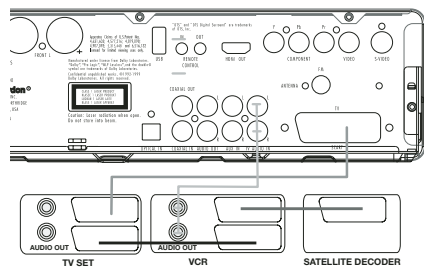

Connecting Set-top Box or Digital Satellite Receiver (method 7) - using coaxial digital cable

To listen to the digital multichannel signal or downmix from Set-top boxes or digital satellite receivers, connect the Coaxial Digital Out of your device to the Coaxial Digital In 9 on the HS controller.

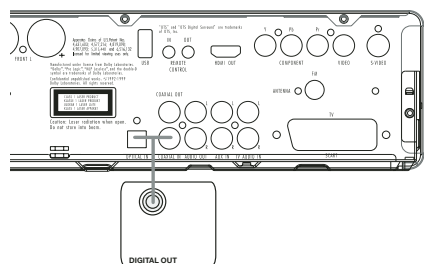

Optional Audio Connections

Aux Input for External Source

You may connect a line-level stereo analog audio source such as a Sat receiver, tape deck, phono preamp of a record player, etc. to the controller's rear panel AUDIO IN Input 7 sockets to enjoy the benefits of your HS system with other source components.

- VCR Connection-Audio (Cables Not Included). To listen to the sound from your stereo VCR through the speakers of this system, connect the Left/Right audio output jacks of your stereo VCR to the Left/Right audio input jacks AUDIO IN 7 of this system.

Aux Output for Recording

To record the sound of the HS system with your VCR or any audio recording device (tape deck, MD, CDR and some others.) the Audio Out jacks 11 should be connected to the analog Record In jacks of the appropriate device. They can also be connected to any audio input on your TV to listen to the sound of your HS controller through the speakers of your TV only, when the amp in your subwoofer is turned off and the volume of the HS controller has been turned down completely. If the speakers of your HS system are active, the volume on your TV should be turned down.

Digital In- and Outputs

Connect the digital output of any digital sources such as an optional CD or DVD changer or player, advanced video game, a digital satellite receiver, HDTV tuner or digital cable set-top box or the output of a compatible computer sound card to the Optical and Coaxial Digital Inputs 9, 10.

Connect the Coaxial Digital Output 15 on the rear panel of the HS to the matching digital input connections on a CD-R or MiniDisc recorder.

Notes when connecting the optical digital audio cable (optional)

- Gently push the cable plug through the built-in shutter that covers the optical digital audio output and connect the cable firmly so that the configurations of both the cable and the connector match.

Speaker Placement

The placement of speakers in a 2.1 audio/home theater system can have a noticeable impact on the quality of sound reproduced.

Position the left-front and right-front speakers so that they are as far away from one another as from the preferred listening position.

If possible, adjust all front loudspeakers so that they are aimed at ear height when you are seated in the listening position.

This will give you the best result for enjoying Dolby Virtual Surround by using only front left and right speakers.

Using these guidelines, you'll find that it takes some experimentation to find the correct location for the front speakers in your particular installation. Don't be afraid to move things around until the system sounds correct. Optimize your speakers so that audio transitions across the front of the room sound smooth.

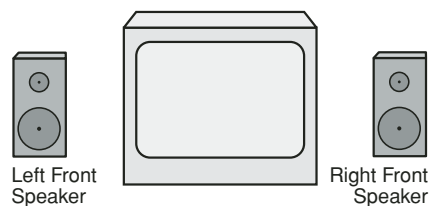

A) Front Channel Speaker Installation with Direct-View TV Sets or Rear-Screen Projectors.

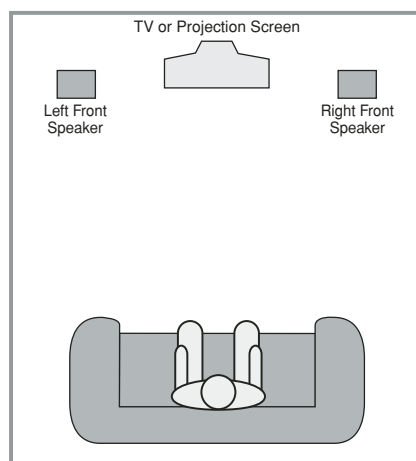

B) The distance between the left and right speakers should be equal to the distance from the seating position to the viewing screen.

Subwoofers produce largely nondirectional sound, so they may be placed almost anywhere in a room. Actual placement should be based on room size. One method of finding the optimal location for a subwoofer is to begin by placing it in the front of the room, about 15cm from a wall, or near the front corner of the room. Another method is to temporarily place the subwoofer in the spot where you will normally sit, and then walk around the room until you find a spot where the subwoofer sounds best. Place the subwoofer in that spot.

Installation and Connections

Connecting the AC Power

Notes

- The Power Requirement is: AC 230V, 50 Hz.
- Connecting to power other than the one listed above may damage the system or cause abnormal operation.
- Before connecting the AC power cord of this system to a wall outlet, connect the speakers and other component cables to the system.
- Connect the AC power cord of the active subwoofer.
- Connect the AC power cords of your TV and any optional components to a wall outlet.

Once the speakers have been placed in the room and connected, the remaining steps are to program the system configuration memories.

First Turn On

You are now ready to power up the HS 200 Controller to begin final adjustments.

1. Plug the **Power Cable 5** into an unswitched AC outlet.
Note that the **Power Indicator 2** will turn orange, indicating that the unit is in the Standby mode.
2. Remove the protective plastic film from the main front-panel lens. If left in place, the film may affect the performance of your remote control.
3. Install the three supplied AAA batteries in the remote as shown. Be certain to follow the (+) and (-) polarity indicators that are on the top of the battery compartment.

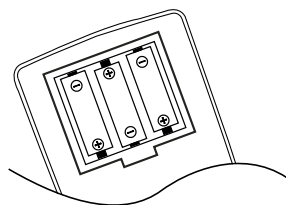

4. Turn the HS 200 on either by pressing the **Power On/Off 2** or the **Input Source Selectors 1** on the remote control.
The **Power Indicator 2** will turn blue to confirm that the unit is on, and the **Main Information Display 1** will also light up.

Basic Play

Preparation

1. Switch the TV ON and select its video input connected to the HS Controller.
2. When you switch on the HS system controller, a Harman Kardon HS welcome image should appear on the screen. If that screen appears distorted or without color, change the appropriate settings at the Video Setting Submenu according to your TV set and to the connection used between the HS Controller and your TV.
3. If there is no picture at all, not even the Harman Kardon screen, check the setting of the video input used on your TV (most SCART inputs on TVs can be configured in the TV's menu). If this doesn't work, connect your TV with different cables to the HS Controller, e.g. via Composite (yellow jacks) or S-Video cables, rather than SCART to view the setup menus until all appropriate "Video menu" settings are made properly.
4. Insert a disc into the Slot Loader **7**.
Hold the disc without touching either of its surfaces, position it with the side you wish to play facing down, align it with the guides, and place it in its proper position.
 - 3" (8 cm) discs or 5" (12 cm) discs can be used.
5. After the discs slides into the loader, it will start playing automatically.
 - With most DVD's, a Disc Menu appears on the screen. Select specific menu item by using ARROW **10** buttons on the remote, then press ENTER **7**.

Disc Playback Features

Skipping tracks or titles/chapters

To move forward or backward through the tracks on a CD or the titles or chapters on a DVD, press Previous/Next **15 16**.

Fast Motion Playback/Fast Search

1. To move forward or backward through the DVD or CD disc being played at fast speed, press Search **18 20** on the remote. Once one of these buttons is pressed, the fast search will continue until Play is pressed.

There are four fast-play speeds. Each press of the Search Buttons will cycle to the next speed in the following order: 2x, 4x, 16x, 100x, indicated by a number of arrow indicators on the right top of the screen.

2. Press PLAY **17** at any time to resume normal playback.

Note that there will be no audio playback during fast-forward or -reverse play of DVD discs. This is normal for DVD, as surround processors cannot process the digital audio streams during fast-play modes; audio will be heard during fast-play of conventional CD's.

Freeze Frame and Frame Advance (with DVD only)

1. Press PAUSE **13** when a DVD is playing to freeze the picture.
2. Each time you press one of the STEP (FWD or REV **15 16**) buttons, the picture advances one frame in the selected direction.
3. Press PLAY **17** to resume normal playback.

Installation and Connections

Slow Motion Playback (with DVD only)

1. When a DVD disc is in pause or freeze frame mode, you may move slowly forward or backward through the program being played at one of four speeds by pressing the SEARCH Buttons **18** **20** on the remote. Each press of the buttons will move to the next speed, indicated by a number of arrow indicators on the right top of the screen.

2. Press PLAY **17** to resume normal playback.

Note that there will be no audio playback during slow-forward or -reverse play of DVD discs. This is normal for DVD, as surround processors cannot process the digital audio streams during slow modes. Slow play is not available for CD.

Notes: Playback features may not be available during the opening credits of a movie. This is intended by the disc author and is not a failure of the HS Controller.

Playback of a DVD with 96 kHz/24-bit audio requires the use of circuitry normally used for other features. Accordingly, Slow Play Reverse and Step Advance features are not available with these discs.

Depending on the structure of a VCD disc, the functions Slow Reverse and Step Reverse may be prohibited or have no function and Fast Playback (Search) may not function.

Fast Playback (Search) will not function with CD's containing MP3 data.

About DivX Movie Files

The DivX disc compatibility of this DVD player is limited by the following:

- the available resolution size of the DivX file should be below 720x576 (W x H) pixels.
- the total number of files and folders on the disc should be less than 999.
- the number of screen frames per second should be below 29.97 frames per second.
- the video and audio structure of recorded file should be interleaved.

The player is capable of playing DivX files with the extensions ".avi".

The player is capable of playing subtitle files with the extensions ".smi", ".srt", ".sub (Micro DVD format only)" or ".ssa". Other subtitle files won't be displayed. Subtitle files need to carry the same name as the movie file (but with either one of the above extensions) and should be located in the same directory.

Playing a DivX Movie Disc

Before playing DivX movie discs, please note the following:

- multi session DVD containing Windows Media Audio files may not be supported.
- open session discs are not supported.
- the DVD player does not support PC data.
- this DVD player does not support an unfinalized disc with a closed session.

1. Insert a disc into the Slot Loader **7**.
2. Press the OSD button of the remote control and select a folder by pressing the up/down cursor buttons and press ENTER. A list of files in the folder appears. If you are in a file list and want to return to the Folder list, use the up/down buttons on the remote to highlight and press ENTER.
3. If you want to view a particular file, press the up/down buttons to highlight a file and press PLAY.

When playing back a DivX movie you can use variable playback functions like fast and slow backward and forward, as well as step forward and step backward.

4. Press STOP to stop the playback.

The DVD player's playback functionalities of DivX video discs will vary depending on the DivX version used for creating your movies.

Surround Mode

One of the most important features of the **HS 200** Controller is its ability to reproduce a full multichannel surround sound field from digital sources, analog matrix surround encoded programs and standard stereo programs by using only a pair of stereo loudspeakers and a subwoofer.

Selection of a surround mode is based on personal taste, as well as the type of program source material being used. For example, motion pictures or TV programs bearing the logo of one of the major surround encoding processes, such as Dolby Surround should be played in the Dolby Virtual Speaker mode. CD's and other stereo sources should be played in Stereo, without the virtual surround processing.

Surround modes and audio formats are selected using the remote. Press the AUDIO button **6** to toggle between the surround modes/audio formats available on the DVD disc. As you press the button, the Surround mode/audio format name will appear on your video display.

When a digital source is present, the HS Controller will automatically select and switch to the correct mode (Dolby Virtual Speaker), regardless of the mode that has been previously selected.

To listen to a DVD-program in traditional two channel stereo, using the front left and front right speakers only (plus the subwoofer if installed and configured), follow the instructions shown in the chapter DVD Sound Mode, in the Audio Settings Menu.

System Setup

System Defaults

The final step of the installation is to establish the system's defaults. It is helpful to take a few minutes to familiarize yourself with these settings, as they may require change before the first use and later from time to time.

General Functionality of the OSD Menu

The complete setup and control of the HS 200 takes place in an advanced user-guided On Screen Display (OSD) menu system. The OSD can be activated by pressing the OSD button **9** on the remote control. Pressing this button again de-activates the OSD.

The main menu consists of a PLAYER Menu, RADIO Menu, TV Menu, AUX Menu, DIGITAL Menu, USB Menu and a SET-UP Menu. The PLAYER Menu will show all information and options available for the disc currently playing. The RADIO Menu will show radio and RDS options. The TV, AUX and DIGITAL Menus show the surround options for these specific audio inputs. The USB Menu will show all information and options available when USB thumb devices or portable hard disks are connected. The SET-UP Menu will help you configure all audio and video settings which are normally only made once.

Depending on how your HS system is connected to your TV set, two different On Screen Displays are available. When the HS is connected via any of the standard definition connections (SCART, S-Video, Composite Video or standard Component Video) the OSD will be icon-based. When the HS is connected via any of the high-definition connections (HDMI or high definition Component Video), the OSD will be text based. In the next chapters we will show both the standard definition version and the high definition version to make the initial setup as easy as possible.

Many Menu's contain Submenus or text lines. These submenus are shown as icons on the left side of the menu, depending on whether you are watching the standard definition OSD or high-definition OSD. They can be highlighted by a white square around the icon or text by moving the cursor with the ARROW **10** buttons. Icons or text can be activated by pressing ENTER **7** when they are highlighted. When ENTER **7** has been pressed, the color of the icon or the circle behind the text will change to dark blue and you will see that the current settings of this submenu will appear on the right side of the menu. Although some Menus have various Submenus and Settings, they are all navigated in the same way. All submenus, settings and options can be accessed with the help of the ARROW (▲▼▶◀ **10**) and ENTER **7** buttons on the remote control.

To change a setting, simply move the cursor to the setting you wish to change. This setting will be highlighted in a white square, and a brief explanation will appear in the Upper Menu Line on the bottom of your screen, together with the

available options for this setting on the Lower Menu Line.

Once the setting is highlighted, pressing ENTER will show an ◀ and ▶ icon next to the current setting to indicate that the setting can be changed by pressing the left or right ARROW Button **10**. Press the ARROW Buttons **10** until the requested setting is shown, and confirm this setting by pressing ENTER **7**. Note that when you cycle through the options for this setting, the cursor cycles through the options on the Lower Menu Line, and the rest of the Display fades out.

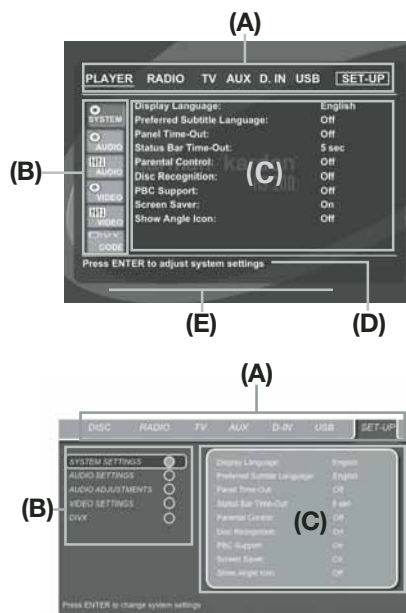

- (A) Main Menu Line
- (B) Submenus
- (C) Current Settings
- (D) Upper Menu Line with Brief Explanation
- (E) Lower Menu Line with Possible Options

Set Up Menu

The first step in checking or changing the system defaults is to access the Setup Menu. First, make certain that the HS Controller is properly connected to a video display, and that power is connected. For this process, however, you do not need to load a disc into the unit.

During STOP, PAUSE or PLAY mode, if you press OSD on the remote, the Main Menu appears on the screen.

This Main Menu and all menus in the following section may look different, listing the settings with different languages, depending on the settings made previously. With the factory default setting all languages are set to "English", that's why with all menus the English version is shown in the manual.

In the SET-UP Menu you will find submenus for making or changing all settings and adjustments for both Audio and Video handling of your HS 200.

To access the SET-UP Menu, press the OSD button **9**, and move the cursor to the right until SET-UP is highlighted. Press ENTER **7** to activate the SYSTEM Settings:

System Settings

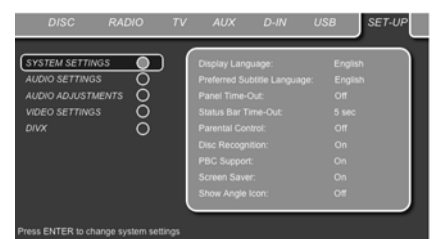

The System Setting Submenu contains the following settings. Follow the explanations in the Upper Menu Line on the bottom of your screen to change the settings.

Display Language: Sets the language in which the OSD menus are shown on your screen.

Preferred Subtitle Language: Defines your preferred subtitle language. Every time a disc contains this subtitle language, it will be shown automatically. If you do not find your preferred language in the list of options, you can select your preferred language by selecting OTHER, and then typing a 4-digit code found in the code list on page 27. You can also set the preferred subtitle language to OFF. In that case no subtitles will be shown.

Panel Time-Out: Sets the time-out interval for the Front Panel Information Display. After the selected time, the display will dim completely.

Status Bar Time-Out: Sets the time-out interval for the Status Bar, after which the Status Bar will disappear from the screen.

Parental Control: Defines a password used to control viewing of restricted programs. The default password is 8888. After pressing the default password, either the parental control setting can be chosen, or a new password. The five standard US rating symbols are "G" (General, level 1), "PG" (Parental Guidance, level 3), "PG13" (Parental Guidance and 13 years old, level 4), "R" (Restricted, level 6) and "NC 17" (from 17 years old, level 7). The DVD will accommodate a total of eight rating steps, as set by the DVD creators. These additional steps allow for more critical control of program playback for all audiences. Level 8: All DVDs can be played.

System Setup

Levels 7 to 2: DVDs for general audiences/ children can be played. Level 1: DVDs for children can be played; DVDs for adults/general audiences are prohibited. Follow the explanations on the screen to set a new password.

Disc Recognition: When set to on, the next time a disc is inserted, the HS will show a "Disc Recognized" message, with the question if you would like to play the disc from the beginning or would like to resume from where you last stopped the disc. The memory can contain information of the last 100 discs played.

PBC Support: Activates PBC (Play Back Control) Support for VCD discs.

Screen Saver: Activates a Screen Saver to prevent image "burn" in a video display device. If you connect the HS Controller to a plasma screen or video projector, we recommend you activate the screen saver at all times.

Show Angle Icon: Determines whether the Angle Icon will appear on the screen when there are different angles available on a DVD disc.

Audio Settings

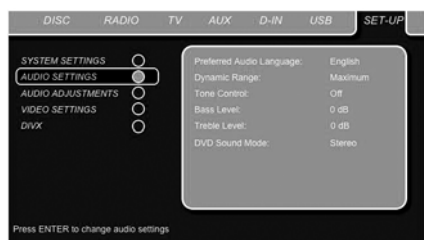

The Audio Setting Submenu contains the following settings. Follow the explanations in the Upper Menu Line on the bottom of your screen to change the settings.

Preferred Audio Language: Defines your preferred audio language. Every time a disc is played that contains this audio language, it will be activated automatically. If you do not find your preferred language in the list of options, you can select your preferred language by selecting OTHER, and then typing a 4-digit code found in the code list on page 27.

Dynamic Range: This setting allows you to take advantage of the programming present on some Dolby Digital recordings to reduce the volume of louder passages while maintaining intelligibility of quieter passages. This means that you may listen to programs at a level that allows the full impact of a soundtrack to be heard at a volume that is lower than you might otherwise use to avoid disturbing others. The HS 200 accomplishes this by compressing the audio to a greater or lesser degree, depending on which setting you choose. Three options are available:

- **MINIMUM** does not make any changes to the original playback, and should be used when the volume setting in the listening room may be as loud as you desire.
- **MEDIUM** applies a moderate amount of compression so that louder passages are a little bit quieter.
- **MAXIMUM** applies more compression so that louder passages are much softer.

Feel free to experiment with the settings at any time.

Tone Control: Activates or De-activates the Bass and Treble settings. Once either the Bass or Treble Settings are changed, the Tone Control automatically switches to ON.

Bass Level: Sets the level of low frequencies.

Treble Level: Sets the level of high frequencies.

DVD Sound Mode: Sets the audio format of the DVD-disc playing (for other sources, see Surround Mode in each respective chapter). Once set to stereo, every surround format on a DVD will be converted to a pure stereo signal. Once set to any of the Dolby Virtual Speaker modes, all stereo signals on a DVD are forced any of the Dolby Virtual Speaker modes into virtual surround for surround playback with only two loudspeakers.

Audio Adjustment

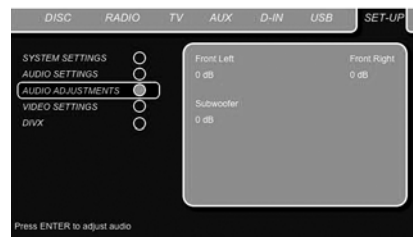

The Audio Adjustment Submenu contains the access to the output level adjustment settings of the HS 200. Follow the explanations in the Upper Menu Line on the bottom of your screen to make adjustments.

Output level adjustment

Output level adjustment is a key part of the configuration process for any surround sound product.

The default settings of the DVD player is 0 dB for all channels. In case you feel adjustments are necessary in your setup, we advise you to make the adjustments using the internal test tone generator.

Once the cursor is moved to any of the speaker level icons, the test noise will be heard from the corresponding speaker. If this is not the case please check whether the loudspeaker is connected to the correct loudspeaker output on the rear panel. The speaker level can be adjusted by pressing ENTER and selecting an appropriate level indicated in the Lower Menu Line. The test noise will stop as soon as the cursor is moved away from any speaker level icon.

System Setup

Video Settings

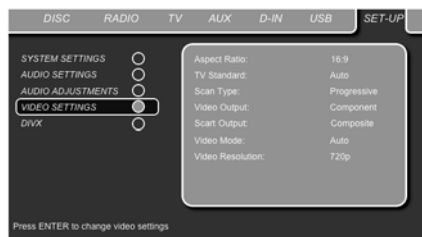

The Video Setting Submenu contains the following settings. Follow the explanations in the Upper Menu Line on the bottom of your screen to change the settings.

Aspect Ratio: This step selects the TV aspect ratio, conventional screen shape (4:3) or widescreen (16:9), according to your TV. If you have a conventional 4:3 TV that can (automatically) switch to show a 16:9 format, you should select 16:9 rather than 4:3.

TV Standard: Sets the output video format i.e. NTSC or PAL, of the HS Controller. If you have a multi standard TV, we recommend the AUTO setting for optimal picture quality.

Scan Type: Sets the component video output to Interlace or Progressive. Before changing the setting to Progressive, make sure that your video display connected to the component output is capable of handling progressive scan signals. As soon as you select progressive scan the scan type, the Video Output will automatically change to Component. All other outputs, composite video on cinch, SCART and S-Video, will be kept Interlaced. The interlaced composite and S-Video outputs remain active for connection to a second (interlaced) video display.

Video Output: Sets the video output type to Scart or Component. Scart will be used for most TV's. Component will be used for most LCD, Plasma and projectors.

Scart Output: Selects which kind of video output signals will be routed over the scart. RGB will be used for most TV's as it provides the best picture quality.

Video Mode: This setting affects only the Component Video Outputs, and it controls how the video signals are optimized for progressive scan display. In most cases, the "automatic" mode is your best choice, as it senses whether the disc being played was originally recorded on video or shot on film. However, in some cases you may wish to compensate for errors in the disc authoring that occur when the frame rate is not properly maintained when films are converted to video. Three choices are available:

- **Auto:** This is the recommended setting, as it lets the HS System analyze the signals from the DVD and adjust the output accordingly.
- **Movie:** Choose this option for optimal playback of material that was shot on film, even though you are viewing it on video via a DVD.
- **Video:** Choose this option for optimal playback of material that was shot directly to video, such as concerts and sports programming.

Video Resolution: Selects the resolution of the video output. When the HS system is connected to either one of the Composite, S-Video or SCART connectors, this setting should be left in Standard.

When you connect your HS system via a digital HDMI or Component Video connection, the preferred setting is either 720p (progressive scan with 720 lines) or 1080i (interlaced with 1080 lines).

If you select any of the 720p or 1080i high resolution formats, all analog video outputs (Composite, S-Video and Scart) will become temporarily in-active.

In order to watch low resolution formats again, press the **Video Output Button**  on the remote control.

Please note that with Component Video non-encrypted movies will be upscaled to 720p. Encrypted movies will not play in 720p and will have to be played back on standard progressive scan component or HDMI.

Video Adjustment



The Video Adjustment Submenu contains access to the Test Screen. Video Adjustments are only possible when the HS source has been set to Standard Definition. First adjust the video display device (TV) with the help of the Test Screen. After that the output settings of the player can be fine-tuned with the Color, Contrast, Brightness, Tint and Black Level settings. In order to change the settings, move the cursor to the "+" or "-" icon on the same line as the setting. Once one of the icons is highlighted, pressing ENTER will increase or decrease the value of the setting, as will be shown in the bar behind the setting. To exit the Video Adjustment Menu, move the cursor to DONE, and press ENTER.



DivX Video On Demand



This code allows you to rent and purchase videos using the DivX VOD service. For more information, visit www.divx.com/vod. Follow the instructions and download the video onto a disc for playback on this unit. Note that all the downloaded videos from DivX VOD can only be played back on this unit.

Once the DivX icon is highlighted, press ENTER to access your personal DivX VOD code.

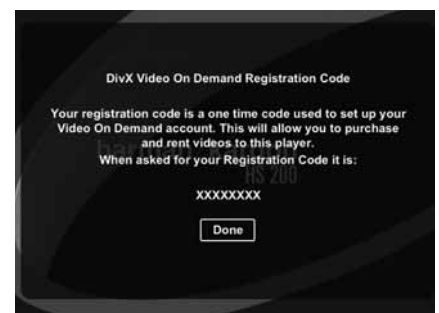

Test Screen

Test Screen

When you activate the Test Screen via the OSD you can activate a still image to test all settings and the video performance of your TV. With the vertical color bars you can test the following:

- proper color intensity setting on your TV,
- the proper color of each bar, showing if the proper video standard is turned on: the colors should be (left to right): black, white, yellow, cyan (turquoise), green, magenta (purple), red, blue, black.
- proper color transition, seen as sharp separation of the bars, S-Video will be better than Video, RGB best of all.
- the performance of the color filter in your TV (with "Video" signals), bar edges should show no vertical crawling dots. Here S-Video and RGB formats usually give no problems.

With the grey scale and the black/white fields below the color bars the brightness and contrast of your screen can be adjusted optimally, see chapter "TV Picture Adjustment" below.

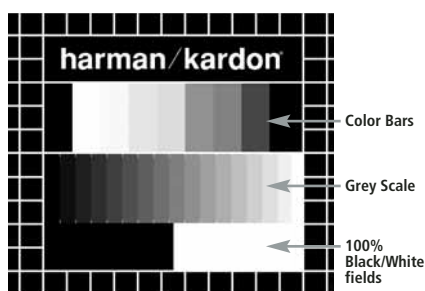

TV Picture Adjustment with Test Screen

These adjustments may be done now, but you can also make them after setup has been finalized.

Brightness adjustment:

1. Turn down the color control on your TV until the color bars are visible in black and white.
2. Adjust the contrast to the lowest level where you still can see all bars within the grey scale in the test picture separately and clearly.
3. Adjust the Brightness so that the bars in the grey scale are all visible. The bar furthest to the left has to be as black as possible rather than grey but the next aside must clearly be differable. All the bars in the grey scale have to be gradually and evenly changing from black to whiter, going from left to right.

Contrast adjustment:

1. Adjust the contrast on your TV until you see a bright white bar in the right low corner of the screen and a deep dark black bar at the left. The optimal contrast setting will depend from your preference and the surrounding light in the TV room.

2. If the brightness of the white bar will no more increase while turning up the contrast or when the borders of the white "harman/kardon" text letters on top will bloom (overlight) into the black areas, what drastically will decrease the sharpness of the script, then the Contrast has been turned up too much. Reduce the contrast until these effects will disappear and the video still looks realistic.
3. If you are watching TV with a usual surrounding daylight, adjust the Contrast so that a normal video picture has about the same looking as the surroundings in your room. By that way the eye is relaxed when watching the TV picture. This contrast setting may be reduced when the surrounding light is dimmed, usually improving the sharpness of a video a lot thereby.
4. The grey scale in the middle line needs to have the same clear difference between each bar as before the contrast adjustment. If not, go back to the brightness adjustment and repeat step 3 and then the contrast adjustments, making only minor adjustments each time for optimisation.

Color adjustment.

1. When the Brightness and the Contrast are set optimally, turn up the color control to the level of your preference. Adjust to the level where the colors look strong but still natural, not overdone. If the color level is too high, depending from the TV used some of the bars will seem wider or the color intensity will not increase while the control is turned up. Then the color control must be reduced again. At the end you should test the color intensity also with a video, e.g. pictures of natural faces, flowers, fruit and vegetables and other well known natural articles of our life most useful for an optimal setting of the color intensity.
2. If your TV has a Tint option (with most European TVs this is available or effective only with NTSC signals, not with PAL), use the large white bar below the Greyscale to tweak the warmth of the picture. Every viewer has a difference in preference as how the glow of the picture should be. Some prefer a little colder picture, some a warmer glow. The Tint function on your TV and the white bar can be used to control this. Adjust the Tint to the level where you feel the white color has the tone you prefer.

Sharpness Adjustment

Contrary to intuition, the picture will appear sharper and clearer with the sharpness, or Edges, setting backed off from the maximum setting. Reduce the sharpness setting on your television, and the Edges setting on the HS 200 video adjustments menu if necessary, to minimize the appearance of any white lines between the bars in the grey scale portion of the test screen.

Convergence and Edge Focus

The crosshatch pattern that surrounds the test screen may be used to evaluate edge focus and convergence in front- or rear-projection video displays. However, the controls used to adjust these parameters are often not user-accessible. In any event, these adjustments are extremely complex, and require proper training and experience to avoid worsening the situation. Therefore, it is recommended that if you are unable to improve the picture using the available controls, contact the video display manufacturer's authorized service representative for assistance.

When all desired setup and configuration entries have been made, use the ▲ ▼ **Navigation Buttons** 10 until "Done" is highlighted at the bottom of the Video Adjustments submenu. Press the **Enter Button** 7 to select it to return to the on-screen menu system. Then, press the **Setup Button** 9 to remove the menu displays from the screen. The unit will return to normal operation and you are ready to enjoy the finest in DVD or CD playback!

Picture Calibration Using the supplied Test Disc

When doing the calibration first insert the disc in the slot loader 7. The disc will start reading, and a main menu will appear on the screen. Select the test pattern required using the ▲ or ▼ **Buttons** 10. Once the pattern appears on the screen, press the **Pause Button** 13 to make sure the test pattern will stay long enough on the screen to make the adjustments.

With the requested test pattern on the screen press the **Mode Button** 42 repeatedly until the TV Button turns red. This will change the remote control to the TV mode, without changing the system's source to TV. Next, press the **Setup Button** 9, and use the ▲ ▼ ► ◀ **Buttons** 10 to select any of the calibration settings to be changed and follow the directions mentioned previously to find the right settings.

When the first calibration setting has been correctly made, press the **Enter Button** 7 to go back to the Setup Menu. Use the ▲ ▼ **Buttons** 10 to select the next calibration setting.

Once all calibration settings for the specific video input have been confirmed, press the **Mode Button** 42 once so that the DVD Button turns red. Should additional calibration settings be made using the supplied disc, these can be selected by pressing the **Disc Menu Button** 12 and select the next calibration setting to be changed. Follow the directions above to make all other calibration settings.

Once all calibration settings have been made, press the **Mode Button** 42 until the DVD Button turns red to change the remote control back to controlling the DVD receiver.

Player/Radio Menu

Using the Status Bar Menu

The on-screen Status Bar contains many playback features. To see the Status Banner Menu, press STATUS **14** on the remote control while a disc is playing. Use the ARROW **10** buttons on the remote to move through the different features in the Status Bar. When a feature is highlighted, press ENTER **7** on the remote to select it and to change it with the help of the options listed on the screen. Press ENTER **7** to activate the change.

Title: The number shown indicates the number of the title that is currently playing.

Chapter: The number shown indicates the number of the chapter that is currently playing on a disc.

Time: This item displays the time in DVD mode. To change the Time mode, first move the cursor to the TIME. The current mode will be highlighted.

Press ENTER and the ARROW button to activate: Title Elapsed, Title Remaining, Chapter Elapsed, Chapter Remaining. Depending on the choice made, the bar will show a graphic view on where the disc is currently playing.

PLAYER Menu



Once all the settings have been made, you are ready to enjoy your HS 200. Once you have inserted a disc into the drawer you can explore the PLAYER Menu by pressing the OSD button. This menu hosts all playback and program features, as well as all disc information. As you will see, the layout of this menu is comparable to the SET-UP Menu. The submenus are shown on the left side of the screen, with INFO activated by default. As in the SET-UP Menu, settings can be highlighted with the ARROW **10** buttons and selected with the ENTER **7** button on the remote control. Options for the settings are shown in the Lower Menu Line on the bottom of the screen.

Disc: Shows the type of the disc.

Audio: Shows the audio track that is currently playing. Options are shown on both Menu Lines on the bottom of the screen.

Playlist: Sets the order in which the current disc is played back.

Repeat: Sets the repeat mode.

Random: Activates Random Playback when possible.

Subtitle: Shows the subtitle of the disc currently playing.

If you have selected any of the high resolution screen formats you will be able to use the Thumbnail function to quickly and easily search for image files. Any JPEG image file that has been created on the computer with a thumbnail image included will show up on the right top of the screen when scrolling through the contents list.

In the PLAYER Menu, the chapter, track or picture currently playing will be marked with an arrow symbol in front of the Chapter (DVD), Track (CD, MP3, WMA) or Picture (JPEG). Chapters, tracks and pictures can be selected from this list at any time by moving the cursor to the desired chapter or track and pressing ENTER **7** to confirm.

The top part of this screen can be de-activated to show the complete Track list on the screen. To de-activate, move the cursor to the upper INFO (or i INFO) Submenu on the left side of the screen. Press ENTER **7** until the icon is highlighted in light blue and the full Track list is visible on the screen. In the same way the Disc List can be removed from the screen by de-activating the PROGRAM Submenu.

When the HS 200 is in play mode, pressing the PLAY button on the remote control will highlight the track being played.

Information Displays



In DVD and MP3 mode, activating the DISC INFO (DVD) or ID3 INFO (MP3) Submenu will show information about the player and the disc currently playing. The first lines will show Disc Type and Disc ID. Below you can compare the Aspect Ratio, Video Standard and Scan Type available on the disc with the actual output of your player or ID3 info for MP3 files.

In the lower part of the screen the Audio Resolution and Audio Format are shown, (DVD only) and at the bottom a graphical presentation of the Video Bit Rate (DVD only) and the Audio Bit Rate of the disc currently playing.

Programmed Play

In STOP mode, the Disc List can be used to create your own program list for DVD, CD, MP3, WMA or JPEG discs. Move the cursor to the right of the menu, into the Disc List. If the disc list is not active, move the cursor to the PROGRAM icon on the left to activate. Move the cursor to the Disc List, and select Clear Program to clear the current list. Once the disc list is clear move the cursor up or down to the first track you would like to program and press ENTER **7**. The cursor will move to the options in the Lower Menu Line. You can either add the selected track (or picture) to the playlist or give it the number you would like it to have in your playlist, or clear the track from the list. Move the cursor down to the next track you would like to program and continue until your playlist is complete. Once completed press PLAY on the remote control or, move the cursor up to the Playlist setting and select Programmed order from the options and press PLAY to start the playback.



Player/Radio Menu

If you have a disc that contains both MP3 files and JPEG images, you can choose to run these simultaneously, mixing the MP3 audio with your own images. The time interval can be chosen in the Picture Setting.

Also you can have the image files follow the audio signal: at the end of each audio track, the next JPEG image will be shown.

With such discs, you can also either listen to the MP3 audio or watch the JPEG video files only. In order to do so, in stop mode, click on the AUDIO or PICTURE icons on the left part of the screen to select or deselect the desired format. Once done, the tracklist will only show the MP3 or JPEG files.

Radio Menu

The FM Tuner in the HS 200 can be used to listen to the Radio. Before listening to the radio stations, you need to preset your favorite stations. The easiest way to do so is with the OSD screen on your monitor.

1. Press the Radio button **1** on the remote control to turn the DVD Receiver on and select Radio as the source. Also make sure that your video monitor connected to the HS 200 is switched on.
2. The TV monitor will show the RADIO Menu, as shown below. You can also select the RADIO Menu with the ARROW **10** keys on the remote control. Once the RADIO tab is highlighted, press ENTER **7** to access the RADIO Menu.



The RADIO Menu shows the selected Audio mode, the name of a station currently played (as long as RDS is available) and a Station list listing the 30 stations with their preset, station name and frequency.

Note: The stations can be preset automatically or manually. The Manual Preset mode is described first. The Auto Preset mode is described later in this manual.

3. The RDS and AUTO Tune functions are switched on by default, shown by the dark blue icons, to make the process of tuning your favorite stations as easy as possible. Move the cursor to the end of the first station line in the menu. The frequency will be highlighted and a brief explanation will appear in the Upper Menu Line on the bottom of the menu.

NOTE: Both RDS and AUTO Tune functions can be switched off by moving the cursor button to the icon at the left side of the menu and pressing the Enter Button on the remote control so that it turns light blue.

4. Pressing the search **18** / **20** will scan the FM band for the first available radio station with acceptable reception. The scan will stop once a station is found and the name of the station will be displayed (as long as RDS is transmitted by the station). The station will be stored automatically on the current preset.

If you know the frequency of your station, you can also tune the frequency directly with the help of the numeric keys of the remote control. Move the cursor to the end of the station line and press the frequency with the numeric keys. Press Enter **7** twice to store.

5. Move the cursor to the next station line in the menu. Follow the directions in step 3 and in the Upper Menu Line to store all your radio stations in the tuner's memory.

Rearranging the station list

Once all the stations have been stored in the memory, you can rearrange the station list, putting your favorite stations on top of the list.

1. Move the cursor in the left column in the station list to the first station you would like to rearrange.
2. Press Enter **7** to activate the current station. The cursor will move to the Lower Menu Line of the screen.
3. Select the desired preset from the list by moving the cursor right or left. Press Enter **7** to activate the change. The cursor will move back to the new station line.
4. Repeat step 3 until all radio stations have been rearranged according to your preferences.

Selecting presets

Once rearranged, presets can be chosen at any time by pressing the numeric key corresponding to the preset you would like to listen to. Depending on whether the RDS function is active, the station name will show on the front panel Information Display.

Pressing the Previous/Next **15** / **16** Button **15** **16** will select the next radio station.

Presets can also be chosen in the Radio Menu. Move the cursor to the preset you would like to listen to and press Enter **7** to activate. An arrow in front of the preset will light to show the active radio station. The cursor can be moved around the menu without changing the current radio station. Pressing the Previous/Next **15** / **16** Button **15** **16** at any position in the menu will select the next radio station, that is for instance from preset 3 to preset 4, even if the cursor is highlighting preset 11. Pressing the Play button will always return the cursor to the current station played, no matter were it was previously (even when another menu is open).

Removing presets

If you wish to remove presets from your preset list, follow the steps below.

1. Move the cursor in the left column in the station list to the preset you would like to remove.
2. Press Enter **7** to activate the current station. The cursor will move to the Lower Menu Line of the screen.
3. Select Remove from the list and press Enter **7**. The cursor will move back to the original station line.
4. Repeat step 3 until all radio stations you would like to delete have been removed.

Auto Preset function

When the cursor is moved to the " # " icon on top of the preset numbers you can activate the Auto Preset function, clear the complete frequency list or restore all default frequencies set by the factory.

When the Auto Preset is selected the tuner will scan the full FM range and store all stations with acceptable reception one after another on the presets. The frequency scanned will appear on the left lower side of the menu while the frequency of each station stored will be shown on the right side of the list. When the complete FM range is scanned or all presets (30) are loaded with stations the scan will stop and the first preset be selected.

You also can stop the scan at any time by pressing the STOP button **19**. Stations can be rearranged by following the explanations in the chapter "Rearranging the station list" on page 23.

RDS Station ID

With the help of RDS (Radio Data System) you can show the name of the station you are currently listening to as well as the station names of all other presets.

The RDS function is set to active by default, shown by the dark blue RDS icon at the left of the menu. In this mode, all station names will be visible both on the OSD menu as well as on the Information Display on the front panel.

If the RDS function on the left side of the menu is inactive (light blue), you will only see the frequency of the current preset shown in the menu and on the front panel display. The Station Name line on top of the menu will disappear, but the name of all other stations preset will keep in the list.

Pressing STATUS **14** on the remote will change the front panels display's indication from the frequency to the name of an RDS station or vice versa and will simultaneously turn the RDS indication in the OSD on or off.

Surround Mode for Tuner

As with all other inputs of the HS 200, you can also select your preferred surround mode when listening to the radio. The actual surround mode is listed on the first line of the tuner menu. Follow the steps below to change the surround format:

1. Move the cursor to the AUDIO line on the top of the tuner menu. The actual surround format will be highlighted. Press Enter **7** to activate the possible surround formats. These will be shown in the bottom line of the menu.
2. Move the cursor right or left, until the desired surround format is highlighted.
3. Press Enter **7** to activate the change. The setting will apply to all tuner presets.

Note: Like with all other inputs of the HS 200 the Audio mode can easily be selected by pressing the AUDIO button **6** on the remote repeatedly until the desired surround mode appears in the first line of the OSD menu.

TV MENU

As a Scart audio/video cable contains both audio and video inputs and outputs in one cable, the Scart connector between the DVD Receiver and the TV can also be used to lead the audio output signals of your TV to the DVD Receiver. In this way your TV programs can be listened to over your HS sound system.

NOTE: Please make sure that the Scart cable used has all pins connected. If not it could be that, only the video signal from the DVD Receiver will be lead to the TV.

1. Press the TV button **1** on the remote control to turn the DVD Receiver on and select TV as the source. Also make sure that your video monitor connected to the HS 200 is switched on.
2. The TV monitor will show the TV Menu, as shown below. You can also select the TV Menu with the ARROW keys **10** on the remote control. Once the TV tab is highlighted, press ENTER **7** to access it.

If the HS controller is already in standby, you can also switch the unit on by pressing the TV button on the remote control.



The TV Menu contains the following settings. Follow the explanations in the Upper Menu Line on the bottom of your screen to change the settings.

Audio: Selects the Surround Mode you would like to use when listening to your TV or other video device connected to the Scart input.

Level adjustment: This setting gives you the possibility to increase or decrease the input level of the TV, so that its sound will have the same level as the radio, the DVD player or the other audio inputs.

AUX MENU

In addition to the built-in DVD-Audio/Video and CD player, the built-in radio and Scart audio input, you can connect one more analog audio source to the HS 200. The analog source can be connected to the AUDIO IN input **7** connectors on the rear panel.

1. Press the AUX button **1** on the remote control to turn the DVD Receiver on and select Aux as the source. Also make sure that your video monitor connected to the HS 200 is switched on.
2. The TV monitor will show the AUX Menu, as shown below. You can also select the AUX Menu with the ARROW keys **10** on the remote control. Once the AUX tab is highlighted, press ENTER **7** to access it.



The AUX Menu contains the following settings. Follow the explanations in the Upper Menu Line on the bottom of your screen to change the settings.

Audio: Selects the Surround Mode you would like to use when listening to your additional analog audio source.

Level adjustment: This setting gives you the possibility to increase or decrease the input level of the analog input, so that its sound will have the same level as the radio, the DVD player or the other audio inputs.

DIGITAL IN MENU

In addition to all analog audio and video sources, the HS 200 also gives you the opportunity to connect two digital audio sources, for instance a digital set-top box or satellite receiver. Connect these sources to either the coaxial or optical digital input connectors on the rear panel.

1. Press the D.IN button **1** on the remote control to turn the DVD Receiver on and select Digital In as the source. Also make sure that your video monitor connected to the HS 200 is switched on.
2. The TV monitor will show the D. IN Menu, as shown below. You can also select the D. IN Menu with the ARROW keys **10** on the remote control. Once the D. IN tab is highlighted, press ENTER **7** to access it.

USB Menu



The DIGITAL IN Menu contains the following settings. Follow the explanations in the Upper Menu Line on the bottom of your screen to change the settings.

Digital Input: Selects either the digital source connected to the coaxial or to the optical digital input as source to listen to.

Audio: Selects the Surround Mode you would like to use when listening to one of the digital audio sources.

Level adjustment: This setting gives you the possibility to increase or decrease the input level of the digital input, so that its sound will have the same level as the radio, the DVD player or the other audio inputs.

Surround Mode Chart

Dolby Digital: Available only with digital input sources encoded with Dolby Digital data. It provides up to five separate main audio channels and a special dedicated Low Frequency Effects channel.

Dolby Digital signals will be down-mixed to 2-channel Stereo or processed to Dolby Virtual Speaker in order to be played back over the 2.1 loudspeaker system.

DTS: Available only with digital input sources encoded with DTS data. Available on special DVD, LD and audio-only discs, DTS provides up to five separate main audio channels and a special dedicated low frequency channel.

DTS signals will be down-mixed to 2-channel Stereo or processed to Dolby Virtual Speaker in order to be played back over the 2.1 loud-speaker system.

Dolby Virtual Speaker: This technology uses a next-generation advanced algorithm to reproduce the dynamics and surround sound effects of a precisely placed 5.1-channel speaker system using only front left and right speakers. In the Reference Mode, the apparent width of the sound across the front image is defined by the distance between the two speakers. The Wide Mode provides a wider, more spacious front image when the two speakers are close together.

USB MENU

The HS systems are among the first to allow direct playback of compatible files from portable USB devices. Two USB On-The-Go inputs are available, one on the right side of the product and one on the rear panel.

Connect your USB thumb drive or portable hard disk, to either of the side or rear panel **USB Inputs 4 17**. If you have more than two devices that you would like to connect at the same time, you can use a standard USB-hub with an external power supply, to which you can connect up to 16 portable USB devices.

1. Press the USB 1 or USB 2 **1** buttons on the remote control to turn the DVD Receiver on. Also make sure that your video monitor connected to the HS 200 is switched on.
2. The TV monitor will show the below screen, allowing you to select which of the file types available on the device you would like to display and play. Showing different file types at the same time like MP3 and JPEG is possible.



3. Move the cursor to the buttons on the lower left side of the screen, and press ENTER to select or deselect the requested file types.

In case several USB devices are connected, all will be shown in the same USB Menu. To differentiate the drives, they will be shown as 1 and 2. USB drives can have more than one partition. If that is the case, the different partitions will be shown as 1a, 1b, 1c etc.

The USB Menu contains the following settings or indications. Follow the explanations in the Upper Menu Line on the bottom of your screen to change the settings.

Disc: Shows the type of the disc.

Audio: Shows the audio track that is currently playing. Options are shown on both menu lines on the bottom of the screen.

Playlist: Sets the order in which the current disc is played back.

Repeat: Sets the repeat mode. (Repeat 1, Repeat Folder).

Random: Activates Random Playback when possible.

Picture: Selects the interval between the current picture on the screen and the next one.

In the USB Menu, the chapter, track or picture currently playing will be marked with an arrow symbol in front of the Track (MP3, WMA) or Picture (JPEG). Tracks and pictures can be selected from this list at any time by moving the cursor to the desired track or file and pressing ENTER **7** to confirm.

The top part of this screen can be de-activated to show the complete Track list on the screen. To de-activate, move the cursor to the upper INFO (or i INFO) Submenu on the left side of the screen. Press ENTER **7** until the icon is highlighted in light blue and the full Track list is visible on the screen. In the same way the Disc list can be removed from the screen by deactivating the PROGRAM Submenu.

When the HS 200 is in play mode, pressing the PLAY button on the remote control will highlight the track being played.

If you have a USB device that contains both music files (MP3, WMA) and JPEG images, you can choose to run these simultaneously, mixing the MP3 or WMA audio with your own images. The time interval can be chosen in the Picture Setting.

With such devices, you can also either listen to the MP3 or WMA audio or watch the JPEG video files only. In order to do so, click in stop mode on the MUSIC, PICTURE or MOVIE icons on the left part of the screen to select or deselect the desired format.

NOTE: The HS 200 will not play back any of the formats SVCD/VCD, MPEG1 (Video), MPEG2 (Video) and audio CD tracks (CDDA) stored on an external USB hard drive.

- You will need a FAT32 pre-formatted external hard disk drive with USB connector. If your disk is formatted with another file system (like NTFS) you will need to re-format it. Please contact your hard disk supplier for more information.
- We recommend creating folders and sort the files by file type (movies, pictures or music). This will allow you to quickly find the file you're looking for.

Learning Codes from a Remote

Learning Codes from a Remote

The HS 200 remote is able to “learn” codes from other remote controls that might be part of your system setup, like the one from your TV. To learn or transfer codes from an IR remote to the AVR’s remote, follow these steps:

1. Place the front of the original remote with the code being sent so that it is facing the **IR Transmitter Window** **40** on the HS remote “head-to-head.” The remotes should be between 2 and 4cm apart.
2. Select the button on the remote that you wish to use as the device selector for the codes about to be entered. This must be any of the **Input Selectors** **1**.
3. Press the **Input Selector** **1** button chosen and the **Learn Button** **34** at the same time. Hold these buttons until the **Program Indicator** **41** flashes amber and the light under the device selector button turns red. Release the buttons. It is important that you begin the next step within 20 seconds.
4. Press the button on the HS remote that you wish to program. Note that the **Program Indicator** **41** will stop flashing.

Important Note: Codes cannot be taught to all buttons on the remote. In these cases the **Program Indicator** **41** keeps flashing after the button was released.

5. As long as the **Program Indicator** **41** is on steadily (for five seconds), press and hold the button on the original remote that you wish to “teach” into the HS remote. If you pressed the button too late or no command was received within five seconds, the **Program Indicator** **41** will flash red three times and then amber, then simply repeat step four. When the **Program Indicator** **41** turns green, release the button on the original remote. Note that the Program Indicator will then begin to flash amber again.

NOTE: If the **Program Indicator** **41** turns red steadily during Step 5, the programming was not successful. Repeat the steps to see if the code will “take.” If the indicator keeps flashing red in step 5, this code cannot be taught.

6. Repeat steps 4 through 5 for each button on the source remote that you wish to transfer to the HS remote.
7. Once all codes have been transferred from the original source remote to the HS remote, press the **Learn** button **34**. This will turn off all LEDs and turn off the learning mode.
8. Repeat Steps 1 through 7 for any additional remotes you wish to “teach” into the HS Remote.

Erasing Learned Codes

The HS’s remote allows you to remove or erase the code learned into a single button for a single device, to remove or erase all the codes that have been learned for a single device, or to erase all commands that have been learned to all devices.

To erase a single learned code from within a single device’s settings, follow these steps:

1. Press and hold both the **Input Selector** **1** within which the individual button to be erased has been programmed and the **Learn** button **34**.
2. When the red LED under the **Input Selector** turns red and the **Program Indicator** **41** flashes amber, release the buttons.
3. Press and release the **Input Selector** **1** again for the device within which the individual button to be erased has been programmed.
4. Press the **7** button **29** three times.
5. Press and release the individual button for which the code is to be erased. The **Program Indicator** **41** will blink green two times and then return to amber.
6. To erase other buttons within the same device, press them as noted in Step 5.
7. When all buttons to be erased have been pressed, press the **Learn** button **34** to complete the process.

To erase all codes within a single device, follow these steps:

1. Press and hold both the **Input Selector** **1** for which you wish to erase the codes and the **Learn** button **34**.
2. When the red LED under the **Input Selector** turns red and the **Program Indicator** **41** flashes amber, release the buttons.
3. Press and release the same **Input Selector** **1** again for the device whose codes you wish to erase.
4. Press the **8** button **29** three times.
5. The **Program/SPL Indicator** **41** will turn off, the red light under the **Input Selector** will flash on and off once and the **Program/SPL Indicator** **41** will flash green three times to indicate that the codes have been erased.

To erase all codes that have been programmed to all devices in the remote, follow these steps:

1. Press any **Input Selector** **1** and also the **Learn** button **34**.
2. When the red LED under the **Input Selector** turns red and the **Program/SPL Indicator** **41** flashes amber, release the buttons.
3. Press and release the same **Input Selector** **1** again.
4. Press the **9** button **29** three times.
5. The **Program/SPL Indicator** **41** will turn off, the red light under the **Input Selector** will flash on and off once and the **Program/SPL Indicator** **41** will flash green three times after some seconds to indicate that the codes have been erased.

Macro Programming

Macros enable you to easily repeat frequently used combinations of commands with the press of a single button on the HS’s remote control. Once programmed, a macro will send out up to 19 different remote codes in a pre-determined sequential order enabling you to automate the process of turning on your system, changing devices, or other common tasks. The HS’s remote can store up to four separate macro command sequences, that are accessed by pressing the **Macro** buttons **21**.

1. To start programming a macro, press the **Mute** button **11** and the **Macro** button **21** to be programmed at the same time. Note that the latest selected **Input Selector** will light red, and the **Program Indicator** **41** will flash amber.

2. Enter the steps for the macro sequence by pressing the button for the actual command step. Although the macro may contain up to 19 steps, each button press, including those used to change devices, counts as a step. The **Program Indicator** **41** will flash green twice to confirm each button press as you enter commands.

NOTE: While entering commands for Power On of any device during a macro sequence, press the **Mute** button **11**. DO NOT press the **Power ON** button **1**.

- Remember to press the appropriate **Input Selector** button **1** before functions are changed to another device.

3. When all the steps have been entered, press the **◀▶ ▲▼** button **10** to enter the commands. The red light under the **Input Selector** **1** will blink and then turn off and the **Program Indicator** **41** will flash green twice to confirm the macro to be programmed.

Example: To program the **Macro 1** **21** button so that it turns on the HS 200 and your TV, follow these steps:

- Press the **Macro 1** button **21** and **Mute** **11** buttons at the same time and then release them.
- Note that the **Program Indicator** will flash amber.
- Press the **TV Selector** **1**.
- Press the **Mute** **11** button to store the HS’s power on command.
- Press the **Screen Power On** button **35** button to store the TV Power On Command.
- Press the **◀▶ ▲▼/Channel Up** button **10** to complete the process and store the macro sequence.

After following these steps, each time you press the **Macro 1** button **21**, the remote will send all Power On commands.

Learning Codes from a Remote

Erasing Macro Commands

To remove the commands that have been programmed into one of the Macro buttons, follow these steps:

1. Press the **Mute** button **11** and the **Macro** button **21** that contains the commands you wish to erase.

2. Note that the **Program Indicator 41** will flash amber, and the red LED under the **Input Selector 1** last used will turn on.

3. Within ten seconds, press the **Mute** button **11**.

4. The red LED under the **Selector** will go out, and the **Program Indicator 41** will turn green and flash three times before it goes out.

5. When the **Program Indicator 41** goes out, the Macro has been erased.

DVD Language Codes

The availability of specific languages for the main audio track or subtitles is dependent on the choices made by a disc's producer. You should always consult the disc's jacket for information on languages for any disc. In the case of some languages, you may be required to enter a code from the list below to access that language.

Language	Code	Language	Code	Language	Code
Abkhazian	6566	Hausa	7265	Rhaero-Romance	8277
Afar	6565	Hebrew	7387	Romanian	8279
Afrikaans	6570	Hindi	7273	Russian	8285
Albanian	8381	Hungarian	7285	Samoan	8377
Ameharic	6577	Icelandic	7383	Sangho	8371
Arabic	6582	Indonesian	7378	Sanskrit	8365
Armenian	7289	Interlingua	7365	Scots Gaelic	7168
Assamese	6583	Interlingue	7369	Serbian	8382
Aymara	6588	Iunpiak	7375	Servo-Groatian	8372
Azerbaijani	6590	Irish	7165	Sesotho	8384
Bashkir	6665	Italian	7384	Setswana	8478
Basque	6985	Japanese	7465	Shona	8378
Bengali; Bangla	6678	Javanese	7487	Sindhi	8368
Bhutani	6890	Kannada	7578	Singhalese	8373
Bihari	6672	Kashmiri	7583	Siswati	8383
Bislama	6673	Kazakh	7575	Slovak	8375
Breton	6682	Kinyarwanda	8287	Slovenian	8376
Bulgarian	6671	Kirghiz	7589	Somali	8379
Burmese	7789	Kirundi	8278	Spanish	6983
Byelorussian	6669	Korean	7579	Sundanese	8385
Cambodian	7577	Kurdish	7585	Swahili	8387
Catalan	6765	Laothian	7679	Swedish	8386
Chinese	9072	Latin	7665	Tagalog	8476
Corsican	6779	Latvian, Lettish	7686	Tajik	8471
Croatian	7282	Lingala	7678	Tamil	8465
Czech	6783	Lithuanian	7684	Tatar	8484
Danish	6865	Macedonian	7775	Telugu	8469
Dutch	7876	Malagsy	7771	Thai	8472
English	6978	Malay	7783	Tibetan	6679
Esperanto	6979	Malayalam	7776	Tigrinya	8473
Estonian	6984	Maltese	7784	Tonga	8479
Faroese	7079	Maori	7773	Tsonga	8483
Fiji	7074	Marathi	7782	Turkish	8482
Finnish	7073	Moldavian	7779	Turkmen	8475
French	7082	Mongolian	7778	Twi	8487
Frisian	7089	Naru	7865	Ukrainian	8575
Galician	7176	Nepali	7869	Urdu	8582
Georgian	7565	Norwegian	7879	Uzbek	8590
German	6869	Occitan	7967	Vietnamese	8673
Greek	6976	Oriya	7982	Volapuk	8679
Greenlandic	7576	Oromo (Afan)	7977	Welsh	6789
Guarani	7178	Panjabi	8065	Wolof	8779
Gujarati	7185	Pashto, Pushto	8083	Xhosa	8872
		Persian	7065	Yiddish	7473
		Polish	8076	Yoruba	8979
		Portuguese	8084	Zulu	9085
		Quechua	8185		

Troubleshooting

If you experience any of the following difficulties while using the system, use this troubleshooting guide to help you remedy the problem. Should any problem persist, consult your authorized Harman Kardon dealer.

No power.

- Is the power cord firmly plugged into the power outlet?
- One of the safety mechanisms may be operating. In this event, unplug the player from the power outlet briefly and then plug it in again.

No picture.

- Check that the system is connected correctly and securely.
- The video cable may be damaged. Replace it with a new one.
- Make sure the system is connected to a video input on the TV (see page 14).
- Make sure the TV is turned on.
- Make sure the correct video input on the TV is selected for viewing with this system.

Noise (interference) appears in the picture.

- Clean the disc.
- If video from this system has to go through your VCR to get to your TV, the copy-protection applied to some DVD programs could affect picture quality. If you still experience problems after checking your connections, please try connecting your DVD system directly to your TV's S-Video input, if your TV is equipped with this input (see page 14).

The aspect ratio of the screen is wrong (picture vertically expanded) when you play a wide picture even though you set "TV DISPLAY" in the SETUP menu to "16:9".

- If you connect the system with the SCART cable, connect directly to the TV. Otherwise the autoswitch function of the aspect ratio for the TV may not work.
- If the TV is not connected with a SCART cable to the HS, or if the autoswitch function does not work you should turn the TV to "16:9" (if possible with your TV).
- Depending on the TV, you may not be able to change the aspect ratio. In that case (TV not adjustable to 16:9) do not select "16:9" in the TV Display. Then, no change of the aspect ratio is needed.

There is no sound or volume is very low.

- Check that the speakers and components are connected correctly and securely.
- Make sure that you have selected the correct source on the system.
- Press **MUTE** on the remote control, if the words MUTE ON are blinking on the front panel display.
- The protective circuitry has been activated because of a short circuit. Turn off the system, eliminate the short circuit problem and turn on the power again.
- The audio interconnect is damaged. Replace it with a new one.
- The system is in pause mode or in slow-motion play mode, or fast forward or fast reverse. Press ► to return to normal play mode.
- Check the speaker settings (see page 19).

The left and right channels are unbalanced or reversed.

- Check that the speakers and components are connected correctly and securely.

Severe hum or noise is heard.

- Check that the speakers and components are connected securely.
- Check that the connecting cords are away from a transformer or motor and at least 3 meters away from fluorescent light.
- Move your TV away from the audio components.
- The plugs and jacks are dirty. Wipe them with a cloth slightly moistened with alcohol.
- Clean the disc.

The volume goes down automatically and can not be increased.

- The internal temperature is too high. Wait approximately one minute for the amplifier to reach normal working temperature.

Radio stations cannot be tuned in.

- Check that the antenna is connected correctly. Adjust the antenna and connect an external antenna if necessary.
- The signal strength of the stations is too weak for automatic tuning. Use manual tuning.
- No stations have been preset.
- The tuner mode is not selected, select the Radio mode.

The remote does not function.

- Remove any obstacles between the remote control and the system.
- Move the remote control closer to the system.
- Point the remote control at the remote sensor on the front panel.
- Replace all the batteries in the remote control with new ones if they are weak.
- Check that the batteries are loaded correctly.

The disc does not play.

- There is no disc inside. ("NO DISC" appears on the front panel display and the TV screen.) Insert a disc.
- Insert the disc correctly with the playback side facing down on the disc tray.
- Clean the disc.
- The system cannot play CD-ROM's, etc. (see page 3).
- DVD with wrong region code (see page 13).

The system starts playing the DVD automatically.

- The DVD features the auto playback function.

Playback stops automatically.

- Some discs include an auto pause signal. When playing such a disc, the system stops playback at the signal.

Troubleshooting

Track Skip or direct select with numeric buttons, Search, Slow-motion play, repeat play or Program play, etc., cannot be done.

- Depending on the DVD or VCD, some of the above operations may not be available (Playback control).

Messages do not appear on the TV screen in the language you want.

- Select the language for Display and Preferred Subtitle in the SETUP menu (see page 18). For all messages from the DVD (DVD menu, subtitles) in the proper language the disc must have the language you selected, if not, another language will be selected.

The audio language cannot be changed when you play a DVD.

- Multilingual sound is not recorded on the DVD.
- Changing the language for the sound by the Audio button on the remote or the Audio line in the Player Menu is prohibited on the DVD. In that case the audio language must be selected by the main menu on the DVD.

The subtitle language cannot be changed when you play a DVD.

- Multilingual subtitles are not recorded on the DVD.
- Changing the language for the subtitles by the Subtitle button on the remote or the Subtitle line in the Player Menu is prohibited on the DVD. In that case the subtitle language must be selected by the main menu on the DVD.

The subtitles cannot be turned off when you play a DVD.

- Depending on the DVD, you may not be able to turn the subtitles off.

The angles cannot be changed when you play a DVD.

- Multi-angles are not recorded on most DVDs.
- Change the angles when the angle mark appears on the TV screen.
- Changing the angles is prohibited on some DVDs.

The system does not operate properly.

- Static electricity, etc., may affect the system's operation. Disconnect the AC power cord, then connect it again.

Please also refer to the Troubleshooting guide contained in your loudspeaker Owners Manual.

Glossary

Bit rate

Value indicating the amount of video data compressed in a DVD per second. The unit is Mbps (megabit per second). 1 Mbps indicates that the data per second is 1,000,000 bits. The higher the bit rate, the larger the amount of data. However, this does not always mean higher quality pictures.

Chapter

Sections of a picture or a music piece on a DVD that are smaller than titles. Many titles are composed of several chapters, but many others are not. Each chapter is assigned a chapter number enabling you to locate the chapter you want.

Dolby Digital ("5.1", "AC-3")

This sound format for movie theaters is more advanced than Dolby Pro Logic Surround. In this format, the rear speakers output stereo sound with an expanded frequency range and a subwoofer channel for deep bass is independently provided. This format is also called "5.1" because the subwoofer channel is counted as 0.1 channel (since it functions only when a deep bass effect is needed). All six channels in this format are recorded separately for superior channel separation. Furthermore, since all the signals are processed digitally, less signal degradation occurs. The name "AC-3" comes from the fact that it is the third audio coding method to be developed by the Dolby Laboratories Licensing Corporation.

Manufactured under license from Dolby Laboratories. "Dolby", "AC-3", "Pro Logic" and the Double-D symbol are trademarks of Dolby Laboratories. Confidential Unpublished Works. © 1992, 1997 Dolby Laboratories, Inc. All rights reserved.

Dolby Pro Logic II Surround

This is a method of decoding stereo or surround recordings that produces five channels from two-channel sound. Compared with the former Dolby Surround system, Dolby Pro Logic II Surround reproduces left-to-right panning more naturally and localizes sounds more precisely. To take full advantage of Dolby Pro Logic II Surround, you should have a pair of rear speakers and a center speaker. The rear speakers output stereo sound.

DTS

Digital audio compression technology developed by Digital Theater Systems, Inc. This technology conforms to 5.1-channel surround. The rear channels are stereo and there is a discrete subwoofer channel in this format. DTS provides 5.1 discrete channels of high quality digital audio. Good channel separation is realized, because all channels are recorded discretely and processed digitally.

Manufactured under license from Digital Theater Systems, Inc. US Pat. No. 5,451,942 and other worldwide patents issued and pending. "DTS" and "DTS Digital Surround" are trademarks of Digital Theater Systems, Inc. © 1996 Digital Theater Systems, Inc. All rights reserved.

MPEG AUDIO

International standard coding system to compress audio digital signals authorized by ISO/IEC. MPEG 1 conforms to up to 2-channel stereo, used on some DVD's as alternate (other language) track.

DVD

A disc that contains up to 8 hours of moving pictures even though its diameter is the same as a CD. The data capacity of a single-layer and single-sided DVD, at 4.7 GB (Giga Byte), is 7 times that of a CD. Furthermore, the data capacity of a dual-layer and single-sided DVD is 8.5 GB, a single-layer and double-sided DVD 9.4 GB, and a dual-layer and double-sided DVD 17 GB. The picture data uses the MPEG 2 format, one of the worldwide standards of digital compression technology. The picture data is compressed to about 1/40 of its original size. The DVD also uses the variable rate coding technology that changes the data to be allocated according to the status of the picture. The audio data is recorded in Dolby Digital, DTS and/or PCM, allowing you to enjoy more natural audio presence. Furthermore, various advanced functions such as multi-angle, multilingual, and subtitles may be provided with the DVD.

Multi-angle function

Various angles or viewpoints of the video camera for a scene are recorded on some DVDs.

Multilingual function

Several languages for the sound or subtitles in a picture are recorded on some DVDs.

Parental Control

A function of some (particular US) DVD's to limit playback of the disc by the age of the users. The limitation varies from disc to disc. When it is activated, playback is completely prohibited, violent scenes are skipped or replaced with other scenes and so on.

Title

The longest sections of a picture or a music piece on a DVD; a movie, etc., for a picture piece on video software; or an album, etc., for a music piece on an audio software. Each title is assigned a title number enabling you to locate the title you want.

Track

Sections of a music piece on a CD. Each track is assigned a track number enabling you to locate the track you want.

PCM

Pulse code modulation, an uncompressed data formation.

NTSC

National TV Systems Committee: a video standard used in USA.

PAL

Phase Alternation Line: a video standard used in many European countries.

HS 200 Controller Specifications

DVD player

Pickup:	Semiconductor laser, wavelength 650nm
Signal system:	NTSC / PAL
Video signal horizontal resolution:	More than 480 lines (DVD)
Video signal-to-noise ratio:	More than 60 dB (DVD)
Audio frequency response: (Stereo)	DVD (PCM): 20 Hz ~ 22 kHz (+/- 1.0 dB) CD (PCM): 20 Hz ~ 20 kHz (+/- 1.0 dB)
Audio signal-to-noise ratio:	More than 80 dB (PCM)
Total harmonic distortion:	Less than 0.01% (PCM)
Dynamic range:	DVD (PCM): More than 85 dB (EIAJ, 2 kHz) CD: More than 85 dB (EIAJ)

FM Tuner

System:	PLL quartz-locked digital synthesizer system
Tuning range:	87.50 ~ 108.00 MHz
Antenna terminals:	75 Ohms, unbalanced
Intermediate frequency:	10.7 MHz

Video Outputs HDMI

Component Video Output:	Y: 1 Vp-p/75 Ohms, sync negative polarity Cr: 0.7 Vp-p/75 Ohms Cb: 0.7 Vp-p/75 Ohms
CVBS Video:	1 Vp-p 75 Ohms
S-video:	Y: 1 Vp-p 75 Ohms C: PAL 0.3 Vp-p 75 Ohms / NTSC 0.286 Vp-p 75 Ohms

Audio line Outputs

Audio L/R:	2 Vrms, 1 kilohms
------------	-------------------

General

Power requirements:	AC 230 V, 50 Hz
Max power consumption:	300 W
Idle power consumption:	Less than 2 W
Dimensions (WxHxD):	350mm x 84mm x 250mm
Weight:	3.8 kg

* Designs and specifications are subject to change without notice.

Depth measurement includes knobs, buttons and terminal connections. Height measurement includes feet and chassis.

All features and specifications are subject to change without notice.

Harman Kardon is a registered trademark of Harman International Industries, Incorporated.

Dolby, Pro Logic and the double-D symbol are trademarks of Dolby Laboratories, registered in the United States and/or other countries. All rights reserved.

DTS is a trademark of Digital Theater Systems, Inc.

Windows Media® Audio (WMA) is a proprietary file format developed by Microsoft.

DivX is a registered trademark of DivX, Inc.

HDMI, the HDMI logo and High-Definition Multimedia Interface are trademarks or registered trademarks of HDMI Licensing LLC.

harman/kardon®

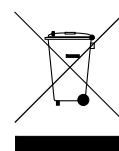

H A Harman International® Company
250 Crossways Park Drive, Woodbury, New York 11797
516.422.HKHK (4545) Fax: 516.682.3523 (USA only)
www.harmankardon.com
Harman Consumer Group, Inc.:
2, route de Tours, 72500 Château-du-Loir, France
© 2007 Harman Kardon, Incorporated
Part No.: 01.00.YS.SM1.E786